



KENYA BIOVAX INSTITUTE

DESIGN, BUILD, ASSEMBLE, INSTALL, COMMISSION, TRAINING AND MAINTENANCE OF ENABLING WORKS OF A GMP-CERTIFIED, 'FILL – AND – FINISH', TURN-KEY STERILE BIOMANUFACTURING FACILITY.

TENDER NO: KBI/IFT/OIT/001/2023-2024

W.P. ITEM NO. D1081 NB/NB/2301 JOB NO. 11221A

PROJECT MANAGER

WORKS SECRETARY

STATE DEPARTMENT FOR PUBLIC WORKS

Ministry Of Lands, Public Works, Housing and Housing and Urban Development

P.O. BOX 30743-00100

NAIROBI

CHIEF ARCHITECT
MINISTRY OF LANDS, PUBLIC WORKS,
HOUSING AND URBAN DEVELOPMENT
P.O. BOX 30743-00100
NAIROBI

CHIEF MECHANICAL ENGINEER (BS)
MINISTRY OF LANDS, PUBLIC WORKS,
HOUSING AND URBAN DEVELOPMENT
P.O. BOX 41191-00100
NAIROBI

CHIEF ELECTRICAL ENGINEER (BS)
MINISTRY OF LANDS, PUBLIC WORKS,
HOUSING AND URBAN DEVELOPMENT
P.O. BOX 41191-00100
NAIROBI

CHIEF QUANTITY SURVEYOR
MINISTRY OF LANDS, PUBLIC WORKS,
HOUSING AND URBAN DEVELOPMENT
P.O. BOX 30743-00100
NAIROBI

CHIEF ENGINEER (STRUCTURAL)
MINISTRY OF LANDS, PUBLIC WORKS,
HOUSING AND URBAN DEVELOPMENT
P.O. BOX 30743-00100
NAIROBI

CLIENT
CHIEF EXECUTIVE OFFICER
KENYA BIOVAX INSTITUTE LIMITED
P.O. BOX 40779-00100
NAIROBI

TABLE OF CONTENTS

PREFACE	v
APPENDIX TOTHE PREFACE.....	vii
GUIDELINES FOR PREPARATION OF TENDER DOCUMENTS.....	vii
1. GENERAL	vii
2. PART 1 - TENDERING PROCEDURES.....	vii
3. PART 2 - PROCUREMENT ENTITY'S REQUIREMENTS.....	viii
4. PART 3 - CONDITIONS OF CONTRACT ANDCONTRACTFORMS.....	viii
INVITATION TOTENDER	x
Invitation To Tender	
SECTION I - INSTRUCTIONSTOTENDERERS.....	1
A. General	1
1. Scope of Tender.....	1
2. Definitions	1
3. Fraud and Corruption	1
4. Eligible Tenderers	1
5. Qualification of the Tenderer.....	3
B. Contents of Tendering Document.....	3
6. Sections of Tendering Document	3
7. Site Visit.....	4
8. Pre-Tender Meeting and a pre-arranged pretender visit of the site of the works	4
9. Clarification of Tender Documents	4
10. Amendment of Tendering Document.....	5
C. Preparation of Tenders	5
11. Cost of Tendering.....	5
12. Language of Tender.....	5
13. Documents Comprising the Tender.....	5
14. Form of Tender and Schedules.....	5
15. Alternative Tenders	6
16. Tender Prices and Discounts	6
17. Currencies of Tender and Payment	6
18. Documents Establishing Conformity of Services.....	7
19. Documents Establishing the Eligibility and Qualifications of the Tenderer	7
20. Period of Validity of Tenders	8
21. Tender Security	8
22. Format and Signing of Tender.....	9
D. Submission and Opening of Tenders	9
23. Sealing and Marking of Tenders	9
24. Deadline for Submission of Tenders	10
25. Late Tenders.....	10

26.	Withdrawal, Substitution and Modification of Tenders	10
27.	Tender Opening.....	10
E.	Evaluation and Comparison of Tenders	12
28.	Confidentiality	12
29.	Clarification of Tenders.....	12
30.	Deviations, Reservations, and Omissions	12
31.	Determination of Responsiveness	12
32.	Non-material Non-conformities	13
33.	Correction of Arithmetical Errors	13
34.	Break down of the Tender Price.....	13
35.	Conversion to Single Currency	14
36.	Margin of Preference and Reservations	14
36.	Nominated Subcontractors	14
37.	Evaluation of Tenders	14
38.	Comparison of Tender Prices	15
39.	Abnormally Low Tenders	15
40.	Abnormally High Tenders.....	16
41.	Qualifications of the Tenderer.....	16
42.	Lowest Evaluated Tender.....	16
42.	Procuring Entity's Right to Accept any Tender, and to Reject any or All Tenders.....	17
45.	Standstill Period	17
46.	Debriefing by the Procuring Entity	17
47.	Letter of Award.....	17
48.	Signing of Contract	17
49.	Performance Security	18
49.	Publication of Procurement Contract	18
50.	Procurement Related Complaints and Administrative Review	18
	Section II - Tender Data Sheet (TDS).....	19
	SECTION III - EVALUATION AND QUALIFICATION CRITERIA.....	23
1.	General Provisions	23
2.	Preliminary examination for Determination of Responsiveness	23
3.	Evaluation of the Technical Proposal.....	23
4.	Tender Evaluation(ITT36)	25
5.	Multiple Contracts (if applicable)	26
6.	Alternative Tenders(ITT13.1)	26
7.	MARGIN OF PREFERENCE.....	26
8.	Post qualification and Contract award (ITT39).....	27
	SECTION IV – TENDERING FORMS	31
	QUALIFICATION FORMS.....	31
1.	FOREIGN TENDERERS 40% RULE.....	31
2.	FORM EQU: EQUIPMENT	32
3.	FORM PER -1	33

4.	FORM PER-2:	34
5.	TENDERERS QUALIFICATION WITHOUT PREQUALIFICATION	36
OTHER FORMS		45
6.	FORM OF TENDER	45
	TENDERER'S ELIGIBILITY- CONFIDENTIAL BUSINESS QUESTIONNAIRE	48
	CERTIFICATE OF INDEPENDENT TENDER DETERMINATION	51
	SELF-DECLARATION FORM	52
	APPENDIX 1- FRAUD AND CORRUPTION	55
	FORM OF TENDER-SECURING DECLARATION	57
	FORM OF TENDER SECURITY (Insurance Guarantee)	58
PART II - PROCURING ENTITY'S INFRASTRUCTURAL FACILITY REQUIREMENTS		61
SECTION VII - PROCURING ENTITY'S REQUIREMENTS		62
1.	Notes on preparing the Procuring Entity's Requirements	62
2.	Scope of the Works [<i>Insert scope</i>]	65
3.	Site Information	65
4.	Specifications	65
5.	Drawings (<i>Tenderer to prepare drawings to demonstrate the intended works</i>)	65
6.	Contractor's Documents	66
7.	Supplementary Information (<i>Procuring Entity to add if any</i>)	66
PART III - THE CONDITIONS OF CONTRACT AND CONTRACT FORMS		67
Section VIII - General Conditions OF CONTRACT (GCC)		67
1.	GENERAL PROVISIONS	67
2.	THE PROCURING ENTITY	74
3.	The Project Manager	75
4.	The Contractor	77
5.	Nominated Subcontractors	85
6.	Staff and Labour	86
7.	Plant, Materials and Workmanship	89
8.	Commencement, Delays and Suspension	91
9.	Tests on Completion	94
10.	Procuring Entity's Taking Over	95
11.	Defects Liability	97
12.	Measurement and Evaluation	99
13.	Variations and Adjustments	100
14.	Contract Price and Payment	104
15.	Termination by Procuring Entity	110
16.	Suspension and Termination by Contractor	112
17.	Risk and Responsibility	113
18.	Insurance	115
19.	Force Majeure	118
20.	Settlement of Claims and Disputes	120

Section IX - Particular Conditions of Contract	124
Section X - Contract Forms	126
FORM No. 1 - NOTIFICATION OF INTENTION TO AWARD.....	127
FORM No. 2 – REQUEST FOR REVIEW	130
FORM No. 3 - LETTER OF AWARD.....	130
FORM No. 4 -CONTRACTAGREEMENT.....	131
FORM No. 5 - PERFORMANCE SECURITY [Option 1 - Unconditional Demand Bank Guarantee].....	132
FORM No. 6 - PERFORMANCE SECURITY [Option 2–Performance Bond]	133
FORM No. 7 - ADVANCEPAYMENTSECURITY	134
FORM No. 8 - RETENTIONMONEYSECURITY	135
FORM No. 9 - BENEFICIAL OWNERSHIP DISCLOSURE.....	135



PROCURING ENTITY:

**Chief Executive Officer
Kenya Biovax Institute Limited
P.O. Box 40779 – 00100
Nairobi
info@biovax.go.ke**

INVITATION TO TENDER (ITT) No. :

KBI/IFT/OIT/001/2023-2024

TENDER NAME:

Design, Build, Assemble, Install, Commission, Training and Maintenance Of Enabling Works Of A GMP-Certified, ‘Fill – And – Finish’, Turn-Key Sterile Biomanufacturing Facility

INVITATION TO TENDER (ITT):

Kenya Biovax Institute Limited
P.O. Box 40779 – 00100
Nairobi
info@biovax.go.ke

CONTRACT NAME AND DESCRIPTION: Design, Build, Assemble, Install, Commission, Training and Maintenance Of Enabling Works Of A GMP-Certified, ‘Fill – And – Finish’, Turn-Key Sterile Biomanufacturing Facility

1. The Kenya Biovax Institute Limited invites sealed tenders for the Design, Build, Assemble, Install, Commission, Training and Maintenance of Enabling Works of A GMP-Certified, ‘Fill – and – Finish’, Turn-Key Sterile Biomanufacturing Facility in Embakasi, Nairobi.
The Supply & Installations is divided into five lots:
 - a) **Lot 1** : *Design, Supply & Installation of Vaccine Bio-Waste Kill System;*
 - b) **Lot 2** : *Design, Supply & Installation of Effluent Treatment Plant (ETP);*
 - c) **Lot 3** : *Drilling & Equipping Borehole;*
 - d) **Lot 4** : *Design, Supply & Installation of Water Treatment Plant;*
 - e) **Lot 5** : *Design and Build of Associated Civil & Builders Works;*
 - f) **Lot 6** : *Concept & detail Design of Fill & Finish Vaccine line;*
2. Tendering will be conducted under open competitive method using a standardized tender document and is open to all qualified and interested Tenderers.
3. Qualified and interested tenderers may obtain further information and inspect the Tender Documents during office hours **0800 to 1600 Hours** at the address given below.
4. Tender documents may be obtained electronically from the Website(www.biovax.go.ke). Tender documents obtained electronically will be free of charge. Tenderers downloading documents from a designated Website shall advise the Procurement Entity that they have downloaded the tender documents, giving full contact addresses of the tenderer (info@biovax.go.ke).
5. Tenders shall be quoted be in Kenya Shillings and shall include all taxes. Tenders shall remain valid for **154** days from the date of opening of tenders.
6. All Tenders must be accompanied by a Tender Security of Ksh. 5,000,000.00
7. Completed tenders must be delivered to the address below on or before *11.00a.m.* Electronic Tenders *will not* be permitted.
8. Tenders will be opened immediately after the deadline date and time specified above or any deadline date and time specified later. Tenders will be publicly opened in the presence of the Tenderers' designated representatives who chooses to attend at the address below.
9. Late tenders will be rejected.
10. The addresses referred to above are:

A. Address for obtaining further information and for purchasing tender documents

Name	Chief Executive Officer,
Physical Address	Kenya Biovax Institute Limited
Address	BioVax Premises, Rd to Utawala Academy, Embakasi
Phone	P.O. Box 40779 – 00100 Nairobi, Kenya. 254-20-2719008

Email procurement@biovax.go.ke

B. Address for Submission of Tenders.

Name Kenya Biovax Institute Limited
Physical Address BioVax Premises, Rd to Utawala Academy, Embakasi
Address P.O. Box 40779 – 00100 Nairobi, Kenya.

C. Address for Opening of Tenders.

Name Kenya Biovax Institute Limited
Physical Address BioVax Premises, Rd to Utawala Academy, Embakasi
Address P.O. Box 40779 – 00100 Nairobi, Kenya.

[Authorized Official (designation, Signature and date)]

Name _____

(Official of the Procuring Entity issuing the invitation)

Designation _____

Signature _____

Date _____



PART 1 - TENDERING PROCEDURES

SECTION I - INSTRUCTIONS TO TENDERERS

A General Provisions

1. Scope of Tender

The Procuring Entity as defined in the Appendix to Conditions of Contract invites tenders for Works Contract as described in the tender documents. The name, identification, and number of lots (contracts) of this Tender Document are **specified in the TDS**.

2. Fraud and Corruption

2.1 The Procuring Entity requires compliance with the provisions of the Public Procurement and Asset Disposal Act, 2015, Section 62 “Declaration not to engage in corruption”. The tender submitted by a person shall include a declaration that the person shall not engage in any corrupt or fraudulent practice and a declaration that the person or his or her sub-contractors are not debarred from participating in public procurement proceedings.

2.2 The Procuring Entity requires compliance with the provisions of the Competition Act 2010, regarding collusive practices in contracting. Any tenderer found to have engaged in collusive conduct shall be disqualified and criminal and/or civil sanctions may be imposed. To this effect, Tenders shall be required to complete and sign the “Certificate of Independent Tender Determination” annexed to the Form of Tender.

2.3 Unfair Competitive Advantage- Fairness and transparency in the tender process require that the Firms or their Affiliates competing for a specific assignment do not derive a competitive advantage from having provided consulting services related to this tender. The Procuring Entity shall indicate in the **TDS** firms (if any) that provided consulting services for the contract being tendered for. The Procuring Entity shall check whether the owners or controllers of the Tenderer are same as those that provided consulting services. The Procuring Entity shall, upon request, make available to any tenderer information that would give such firm unfair competitive advantage over competing firms.

2.4 Tenderers shall permit and shall cause their agents (whether declared or not), subcontractors, sub-consultants, service providers, suppliers, and their personnel, to permit the Procuring Entity to inspect all accounts, records and other documents relating to any initial selection process, prequalification process, tender submission, proposal submission, and contract performance (in the case of award), and to have them audited by auditors appointed by the Procuring Entity.

3 Eligible Tenderers

3.1 A Tenderer may be a firm that is a private entity, a state-owned enterprise or institution subject to ITT3.7 or any combination of such entities in the form of a joint venture (JV) under an existing agreement or with the intent to enter in to such an agreement supported by a letter of intent. In the case of a joint venture, all members shall be jointly and severally liable for the execution of the entire Contract in accordance with the Contract terms. The JV shall nominate a Representative who shall have the authority to conduct all business for and on behalf of any and all the members of the JV during the tendering process and, in the event the JV is awarded the Contract, during contract execution. The maximum number of JV members shall be specified in the **TDS**.

3.2 A Tenderer shall not have a conflict of interest. Any tenderer found to have a conflict of interest shall be disqualified. A tenderer may be considered to have a conflict of interest for the purpose of this tendering process, if the tenderer:

- a. Directly or indirectly controls, is controlled by or is under common control with another tenderer; or
- b. Receives or has received any direct or indirect subsidy from another tenderer; or
- c. Has the same legal representative as another tenderer; or
- d. Has a relationship with another tenderer, directly or through common third parties, that puts it in a position to influence the tender of another tenderer, or influence the decisions of the Procuring Entity regarding this tendering process; or
- e. Any of its affiliates participated as a consultant in the preparation of the design or technical specifications of the works that are the subject of the tender; or
- f. Any of its affiliates has been hired (or is proposed to be hired) by the Procuring Entity as Engineer for the Contract implementation; or

- h) Would be providing goods, works, or non-consulting services resulting from or directly related to consulting services for the preparation or implementation of the contract specified in this Tender Document or
 - i) Has a close business or family relationship with a professional staff of the Procuring Entity who:
 - i) Are directly or indirectly involved in the preparation of the Tender document or specifications of the Contract, and/or the Tender evaluation process of such contract; or
 - ii) would be involved in the implementation or supervision of such Contract unless the conflict stemming from such relationship has been resolved in a manner acceptable to the Procuring Entity throughout the tendering process and execution of the Contract.
- 3.3 Public Officers of the Procuring Entity, their Spouses, Child, Parent, Brothers or Sister. Child, Parent, Brother or Sister of a Spouse, their business associates or agents and firms/organizations in which they have a substantial or controlling interest shall not be eligible to tender or be awarded a contract. Public Officers are also not allowed to participate in any procurement proceedings.
- 3.4 A tenderer shall not be involved in corrupt, coercive, obstructive, collusive or fraudulent practice. A tenderer that is proven to have been involved any of these practices shall be automatically disqualified and would not be awarded a contract.
- 3.5 A Tenderer (either individually or as a JV member) shall not participate in more than one Tender, except for permitted alternative tenders. This includes participation as a subcontractor in other Tenders. Such participation shall result in the disqualification of all Tenders in which the firm is involved. A firm that is not a tenderer or a JV member may participate as a subcontractor in more than one tender.
- 3.6 A Tenderer may have the nationality of any country, subject to the restrictions pursuant to ITT4.8. A Tenderer shall be deemed to have the nationality of a country if the Tenderer is constituted, incorporated or registered in and operates in conformity with the provisions of the laws of that country, as evidenced by its articles of incorporation (or equivalent documents of constitution or association) and its registration documents, as the case may be. This criterion also shall apply to the determination of the nationality of proposed subcontractors or sub-consultants for any part of the Contract including related Services.
- 3.7 A Tenderer that has been debarred by the PPRA from participating in public procurement shall be ineligible to be prequalified for a tender or be awarded a contract. The list of debarred firms and individuals is available from the website of PPRA www.ppra.go.ke.
- 3.8 Tenderers that are state-owned enterprises or institutions may be eligible to compete and be awarded a Contract (s) only if they are accredited by PPRA to be (i) a legal public entity of the state Government and/or public administration, (ii) financially autonomous and not receiving any significant subsidies or budget support from any public entity or Government, and (iii) operating under commercial law and vested with legal rights and liabilities similar to any commercial enterprise to enable it compete with firms in the private sector on an equal basis.
- 3.9 A Firms and individuals may be in eligible if their countries of origin (a) as a matter of law or official regulations, Kenya prohibits commercial relations with that country, or (b) by an act of compliance with a decision of the United Nations Security Council taken under Chapter VII of the Charter of the United Nations, Kenya prohibits any import of goods or contracting of works or services from that country, or any payments to any country, person, or entity in that country. A tenderer shall provide such documentary evidence of eligibility satisfactory to the Procuring Entity, as the Procuring Entity shall reasonably request.
- 3.10 Foreign tenderers are required to source at least forty (40%) percent of their contract inputs (in supplies, subcontracts and labor) from national suppliers and contractors. To this end, a foreign tenderer shall provide in its tender documentary evidence that this requirement is met. Foreign tenderers not meeting this criterion will be automatically disqualified. Information required to enable the Procuring Entity determine if this condition is met shall be provided in “SECTION III- EVALUATION AND QUALIFICATION CRITERIA, Item9”.
- 3.11 Pursuant to the eligibility requirements of ITT3.10, at tender is considered a foreign tenderer, if it is registered in Kenya, has less than 51 percent ownership by nationals of Kenya and if it does not subcontract foreign contractors more than 10 percent of the contract price, excluding provisional sums. JVs are considered as foreign tenderers if the individual member firms are registered in Kenya have less 51 percent ownership by nationals of Kenya. The JV shall not subcontract to foreign firms more than 10 percent of the contract price, excluding provisional sums.

- 3.12 The National Construction Authority Act of Kenya requires that all local and foreign contractors be registered with the National Construction Authority and be issued with a Registration Certificate before they can undertake any construction works in Kenya. Registration shall not be a condition for tender, but it shall be a condition of contract award and signature. A selected tenderer shall be given opportunity to register before such award and signature of contract. Application for registration with National Construction Authority may be accessed from the website www.nca.go.ke.
- 3.13 The Competition Act of Kenya requires that firms wishing to tender as Joint Venture under takings which may prevent, distort or lessen competition in provision of services are prohibited unless they are exempt in accordance with the provisions of Section 25 of the Competition Act, 2010. JVs will be required to seek for exemption from the Competition Authority. Exemption shall not be a condition for tender, but it shall be a condition of contract award and signature. AJV tenderer shall be given opportunity to seek such exemption as a condition of award and signature of contract. Application for exemption from the Competition Authority of Kenya may be accessed from the website www.cak.go.ke

4 Eligible Goods, Equipment, and Services

- 4.1 Goods, equipment and services to be supplied under the Contract may not have their origin in any country that is not eligible under ITT3.9. At the Procuring Entity's request, Tenderers may be required to provide evidence of the origin of Goods, equipment and services.
- 4.2 Any goods, works and production processes with characteristics that have been declared by the relevant national environmental protection agency or by other competent authority as harmful to human beings and to the environment shall not be eligible for procurement.

5 Tenderer's Responsibilities

- 5.1 The tenderer shall bear all costs associated with the preparation and submission of his/her tender, and the Procuring Entity will in no case be responsible or liable for those costs.
- 5.2 The tenderer, at the tenderer's own responsibility and risk, is encouraged to visit and examine the Site of the Works and its surroundings, and obtain all information that may be necessary for preparing the tender and entering into a contract for construction of the Works. The costs of visiting the Site shall be the tenderer's own expense.
- 5.3 The Tenderer and any of its personnel or agents will be granted permission by the Procuring Entity to enter upon its premises and lands for the purpose of such visit. The Tenderer shall indemnify the Procuring Entity against all liability arising from death or personal injury, loss of or damage to property, and any other losses and expenses incurred as a result of the inspection.
- 5.4 The tenderer shall provide in the Form of Tender and Qualification Information, a preliminary description of the proposed work method and schedule, including charts, as necessary or required.

B. Contents of Tender Documents

6 Sections of Tender Document

- 6.1 The tender document consists of Parts 1, 2, and 3, which includes all the sections specified below, and which should be read in conjunction with any Addenda issued in accordance with ITT 10.

PART 1 Tendering Procedures

- i) Section I- Instructions to Tenderers (ITT)
- ii) Section II- Tender Data Sheet (TDS)
- iii) Section III- Evaluation and Qualification Criteria
- iv) Section IV- Tendering Forms

PART 2 Works Requirements

- i) Section V- Specifications
- ii) Section VI- Drawings

PART 3 Conditions of Contract and Contract Forms

- i) Section VII- General Conditions of Contract (GCC)
- ii) Section VII- Special Conditions of Contract (SC)
- iii) Section IX- Contract Forms

- 6.2 The Invitation to Tender Document Notice issued by the Procuring Entity is not part of the Tender document.
- 6.3 Unless obtained directly from the Procuring Entity, the Procuring Entity is not responsible for the completeness of the Tender document, responses to requests for clarification, the minutes of the pre-Tender meeting (if any), or Addenda to the Tender document in accordance with ITT 10. In case of any contradiction, documents obtained directly from the Procuring Entity shall prevail.
- 6.4 The Tenderer is expected to examine all instructions, forms, terms, and specifications in the Tender Document and to furnish with its Tender all information and documentation as is required by the Tender document.

7 Site Visit

- 7.1 The Tenderer, at the Tenderer's own responsibility and risk, is encouraged to visit and examine the Site of the Required Services and its surroundings and obtain all information that may be necessary for preparing the Tender and entering into a contract for the Services. The costs of visiting the Site shall be at the Tenderer's own expense.

8 Pre-Tender Meeting and a pre-arranged pretender visit of the site of the works

- 8.1 The Procuring Entity shall specify in the **TDS** if a pre-tender conference will be held, when and where. The Procuring Entity shall also specify in the **TDS** if a pre-arranged pretender visit of the site of the works will be held and when. The Tenderer's designated representative is invited to attend a pre-arranged pretender visit of the site of the works. The purpose of the meeting will be to clarify issues and to answer questions on any matter that may be raised at that stage.
- 8.2 The Tenderer is requested to submit any questions in writing, to reach the Procuring Entity not later than the period specified in the **TDS** before the meeting.
- 8.3 Minutes of the pre-Tender meeting and the pre-arranged pretender visit of the site of the works, if applicable, including the text of the questions asked by Tenderers and the responses given, together with any responses prepared after the meeting, will be transmitted promptly to all Tenderers who have acquired the Tender Documents in accordance with ITT6.3. Minutes shall not identify the source of the questions asked.
- 8.4 The Procuring Entity shall also promptly publish anonymized (*no names*) Minutes of the pre-Tender meeting and the pre-arranged pretender visit of the site of the works at the web page identified **in the TDS**. Any modification to the Tender Documents that may become necessary as a result of the pre-Tender meeting shall be made by the Procuring Entity exclusively through the issue of an Addendum pursuant to ITT10 and not through the minutes of the pre-Tender meeting. Nonattendance at the pre-Tender meeting will not be a cause for disqualification of a Tenderer.

9 Clarification of Tender Documents

- 9.1 A Tenderer requiring any clarification of the Tender Document shall contact the Procuring Entity in writing at the Procuring Entity's address specified in the **TDS** or raise its enquiries during the pre-Tender meeting and the pre-arranged pretender visit of the site of the works if provided for in accordance with ITT8.4. The Procuring Entity will respond in writing to any request for clarification, provided that such request is received no later than the period specified in the **TDS** prior to the deadline for submission of tenders. The Procuring Entity shall forward copies of its response to all tenderers who have acquired the Tender Documents in accordance with ITT 6.3, including a description of the inquiry but without identifying its source. If so specified in the **TDS**, the Procuring Entity shall also promptly publish its response at the web page identified in the **TDS**. Should the clarification result in changes to the essential elements of the Tender Documents, the Procuring Entity shall amend the Tender Documents appropriately following the procedure under ITT 10.

10 Amendment of Tendering Document

- 10.1 At any time prior to the deadline for submission of Tenders, the Procuring Entity may amend the Tendering document by issuing addenda.
- 10.2 Any addendum issued shall be part of the tendering document and shall be communicated in writing to all who have obtained the tendering document from the Procuring Entity in accordance with ITT 6.3. The Procuring Entity shall also promptly publish the addendum on the Procuring Entity's webpage in accordance with ITT8.1.
- 10.3 To give prospective Tenderers reasonable time in which to take an addendum into account in preparing their Tenders, the Procuring Entity shall extend, as necessary, the deadline for submission of Tenders, in accordance with ITT 24.2 below 2.

C. Preparation of Tenders

11 Cost of Tendering

- 11.1 The Tenderer shall bear all costs associated with the preparation and submission of its Tender, and the Procuring Entity shall not be responsible or liable for those costs, regardless of the conduct or outcome of the tendering process.

12 Language of Tender

- 12.1 The Tender, as well as all correspondence and documents relating to the tender exchanged by the tenderer and the Procuring Entity, shall be written in the English Language. Supporting documents and printed literature that are part of the Tender may be in the same language.

13 Documents Comprising the Tender

- 13.1 The Tender shall comprise the following:
 - a) Form of Tender prepared in accordance with ITT 14;
 - b) Schedules of personnel, and work completed in accordance with ITT 14 and ITT 16;
 - c) Tender Security or Tender-Securing Declaration, in accordance with ITT 21.1;
 - d) Alternative Tender, if permissible, in accordance with ITT 15;
 - e) Authorization: written confirmation authorizing the signatory of the Tender to commit the Tenderer, in accordance with ITT 22.3;
 - f) Qualifications: documentary evidence in accordance with ITT 19 establishing the Tenderer's qualifications to perform the Contract if its Tender is accepted;
 - g) Conformity: a technical proposal in accordance with ITT 18;
 - h) Any other document required in the **TDS**.

In addition to the requirements under ITT 13.1, Tenders submitted by a JV shall include a copy of the Joint Venture Agreement entered into by all members. Alternatively, a letter of intent to execute a Joint Venture Agreement in the event of a successful Tender shall be signed by all members and submitted with the Tender, together with a copy of the proposed Agreement. The Tenderer shall serialize pages of all tender documents submitted.

14 Form of Tender and Schedules

- 14.1 The Form of Tender and Schedules, shall be prepared using the relevant forms furnished in Section IV, Tendering Forms. The forms must be completed without any alterations to the text, and no substitutes shall be

Accepted except as provided under ITT 22.3. All blank spaces shall be filled in with the information requested. The Tenderer shall chronologically serialize all pages of the tender documents submitted.

14.2 The Tenderer shall furnish in the Form of Tender information on commissions and gratuities, if any, paid or to be paid to agents or any other party relating to this Tender.

15 Alternative Tenders

15.1 Unless otherwise specified in the **TDS**, alternative Tenders shall not be considered.

15.2 When alternative times for completion are explicitly invited, a statement to that effect **will be included in the TDS**, and the method of evaluating different alternative times for completion will be described in Section III, Evaluation and Qualification Criteria.

15.3 Except as provided under ITT 15.4 below, Tenderers wishing to offer technical alternatives to the requirements of the Tender Documents must first price the Procuring Entity's design as described in the Tender Documents and shall further provide all information necessary for a complete evaluation of the alternative by the Procuring Entity, including drawings, design calculations, technical specifications, breakdown of prices, and proposed construction methodology and other relevant details. Only the technical alternatives, if any, of the Tenderer with the Winning Tender conforming to the basic technical requirements shall be considered by the Procuring Entity.

15.4 When specified in the **TDS**, Tenderers are permitted to submit alternative technical solutions for specified parts of the Works, and such parts **will be identified in the TDS**, as will the method for their evaluation and described in Section VII, Works' Requirements.

16 Tender Prices and Discounts

16.1 The prices and discounts (including any price reduction) quoted by the Tenderer in the Form of Tender shall conform to the requirements specified below.

16.2 The Tenderer shall price for all items of the Works, including design, management and quality control costs and shall be assumed to have included in the tender price all associated costs, including costs to meet Public Authorities' requirements.

16.3 The price to be quoted in the Form of Tender, in accordance with ITT 14.1, shall be the total price of the Tender, excluding any discounts offered.

16.4 The Tenderer shall quote any discounts and the methodology for their application in the Form of Tender, in accordance with ITT 14.1.

16.5 It will be specified in the **TDS** if the rates and prices quoted by the Tenderer are or are not subject to adjustment during the performance of the Contract in accordance with the provisions of the Conditions of Contract, except in cases where the contract is subject to fluctuations and adjustments, not fixed price. In such a case, the Tenderer shall furnish the indices and weightings for the price adjustment formulae in the Schedule of Adjustment Data and the Procuring Entity may require the Tenderer to justify its proposed indices and weightings.

16.6 Where tenders are being invited for individual lots (contracts) or for any combination of lots (packages), tenderers wishing to offer discounts for the award of more than one Contract shall specify in their Tender the price reductions applicable to each package, or alternatively, to individual Contracts within the package. Discounts shall be submitted in accordance with ITT 16.4, provided the Tenders for all lots (contracts) are opened at the same time.

16.7 All duties, taxes, and other levies payable by the Contractor under the Contract, or for any other cause, as of the date 28 days prior to the deadline for submission of Tenders, shall be included in the rates and prices and the total Tender Price submitted by the Tenderer.

17 Currencies of Tender and Payment

17.1 The currency (ies) of the Tender and the currency (ies) of payments shall be the same.

17.2 Tenderers shall quote entirely in Kenya Shillings.

- 17.2.1 A Tenderer expecting to incur expenditures in other currencies for inputs to the Works supplied from outside Kenya (referred to as “the foreign currency requirements”) shall indicate so in the Financial Proposal the percentage (s) of the Tender Price (excluding Provisional Sums), needed by the Tenderer for the payment of such foreign currency requirements, limited to no more than two foreign currencies.
- 17.2.2 The rates of exchange to be used by the Tenderer in arriving at the local currency equivalent and the percentage (s) mentioned in (a) above shall be specified by the Tenderer in the **TDS**, and shall apply for all payments under the Contract so that no exchange risk will be borne by the successful Tenderer.
- 17.3 Tenderers may be required by the Procuring Entity to justify, to the Procuring Entity's satisfaction, their local and foreign currency requirements, and to substantiate that the amounts included in the unit rates and prices and shown in the Schedule of Adjustment Data in the Appendix to Tender are reasonable, in which case a detailed breakdown of the foreign currency requirements shall be provided by Tenderers.

18 Documents Comprising the Technical Proposal

- 18.1 The Tenderer shall furnish a technical proposal including a statement of work methods, equipment, personnel, schedule and any other information as stipulated in Section IV, Tender Forms, insufficient detail to demonstrate the adequacy of the Tenderer's proposal to meet the work's requirements and the completion time.

19 Documents Establishing the Eligibility and Qualifications of the Tenderer

- 19.1 Tenderers shall complete the Form of Tender, included in Section IV, Tender Forms, to establish Tenderer's eligibility in accordance with ITT 4.
- 19.2 In accordance with Section III, Evaluation and Qualification Criteria, to establish its qualifications to perform the Contract the Tenderer shall provide the information requested in the corresponding information sheets included in Section IV, Tender Forms.
- 19.3 If a margin of preference applies as specified in accordance with ITT 36.1, national tenderers, individually or in joint ventures, applying for eligibility for national preference shall supply all information required to satisfy the criteria for eligibility specified in accordance with ITT 36.1.
- 19.4 Tenderers shall be asked to provide, as part of the data for qualification, such information, including details of ownership, as shall be required to determine whether, according to the classification established by the Procuring Entity, a particular contractor or group of contractors qualifies for a margin of preference. Further the information will enable the Procuring Entity identify any actual or potential conflict of interest in relation to the procurement and/or contract management processes, or a possibility of collusion between tenderers, and there by help to prevent any corrupt influence in relation to the procurement process or contract management.
- 19.5 The purpose of the information described in **ITT 19.2** above overrides any claims to confidentiality which a tenderer may have. There can be no circumstances in which it would be justified for a tenderer to keep information relating to its ownership and control confidential where it is tendering to undertake public sector work and receive public sector funds. Thus, confidentiality will not be accepted by the Procuring Entity as a justification for a Tenderer's failure to disclose, or failure to provide required information on its ownership and control.
- 19.6 The Tenderer shall provide further documentary proof, information or authorizations that the Procuring Entity may request in relation to ownership and control which information on any changes to the information which was provided by the tenderer under ITT19.5. The obligations to require this information shall continue for the duration of the procurement process and contract performance and after completion of the contract, if any change to the information previously provided may reveal a conflict of interest in relation to the award or management of the contract.
- 19.7 All information provided by the tenderer pursuant to these requirements must be complete, current and accurate as at the date of provision to the Procuring Entity. In submitting the information required pursuant to these requirements, the Tenderer shall warrant that the information submitted is complete, current and accurate as at the date of submission to the Procuring Entity.
- 19.8 If a tenderer fails to submit the information required by these requirements, its tenderer will be rejected. Similarly, if the Procuring Entity is unable, after taking reasonable steps, to verify to a reasonable degree the information submitted by a tenderer pursuant to these requirements, then the tender will be rejected.

- 19.9 If information submitted by a tenderer pursuant to these requirements, or obtained by the Procuring Entity (whether through its own enquiries, through notification by the public or otherwise), shows any conflict of interest which could materially and improperly benefit the tenderer in relation to the procurement or contract management process, then:
- i) If the procurement process is still ongoing, the tenderer will be disqualified from the procurement process,
 - ii) If the contract has been awarded to that tenderer, the contract award will be set aside,
 - iii) The tenderer will be referred to the relevant law enforcement authorities for investigation of whether the tenderer or any other persons have committed any criminal offence.
- 19.10 If a tenderer submits information pursuant to these requirements that is incomplete, inaccurate or out-of-date, or attempts to obstruct the verification process, then the consequences of ITT 19.9 will ensue unless the tenderer can show to the reasonable satisfaction of the Procuring Entity that any such act was not material, or was due to genuine error which was not attributable to the intentional act, negligence or recklessness of the tenderer.

20 Period of Validity of Tenders

- 20.1 Tenders shall remain valid for the Tender Validity period specified **in the TDS**. The Tender Validity period starts from the date fixed for the Tender submission deadline (as prescribed by the Procuring Entity in accordance with ITT 24.1). A tender valid for a shorter period shall be rejected by the Procuring Entity as non-responsive.
- 20.2 In exceptional circumstances, prior to the expiration of the Tender validity period, the Procuring Entity may request Tenderers to extend the period of validity of their Tenders. The request and the responses shall be made in writing. If a Tender Security is requested in accordance with ITT 21, it shall also be extended for thirty (30) days beyond the deadline of the extended validity period. A Tenderer may refuse the request without forfeiting its Tender security. A tenderer granting the request shall not be required or permitted to modify its Tender, except as provided in ITT 26.3.

21 Tender Security

- 21.1 The Tenderer shall furnish as part of its Tender, either a Tender-Securing Declaration or a Tender Security as specified in the **TDS**, in original form and, in the case of a Tender Security, in the amount and currency **specified in the TDS**. A Tender-Securing Declaration shall use the form included in Section IV, Tender Forms.
- 21.2 If a Tender Security is specified pursuant to ITT 21.1, the Tender Security shall be a demand guarantee in any of the following forms at the Tenderer's option:
- i) cash;
 - ii) A bank guarantee;
 - iii) A guarantee by an insurance company registered and licensed by the Insurance Regulatory Authority listed by the Authority; or
 - iv) A guarantee issued by a financial institution approved and licensed by the Central Bank of Kenya, and from a reputable source, and an eligible country.
- 21.3 If an unconditional bank guarantee is issued by a bank located outside Kenya, the issuing bank shall have a correspondent bank located in Kenya to make it enforceable. The Tender Security shall be valid for thirty (30) days beyond the original validity period of the Tender, or beyond any period of extension if requested under ITT 24.2.
- 21.4 If a Tender Security or Tender-Securing Declaration is specified pursuant to ITT 21.1, any Tender not accompanied by a substantially responsive Tender Security or Tender-Securing Declaration shall be rejected by the Procuring Entity as non-responsive.
- 21.5 The Tender Security shall be returned/released as promptly as possible
- a. The procurement proceedings are terminated;
 - b. The procuring entity determines that none of the submitted tenders is responsive;
 - c. A bidder declines to extend the tender validity.
 - d. Once the successful Tenderer has signed the Contract and furnished the required Performance Security.

21.6 The Tender Security may be forfeited or the Tender-Securing Declaration executed:

- a) If a Tenderer withdraws its Tender during the period of Tender validity specified by the Tenderer on the Form of Tender; or
- b) If the successful Tenderer fails to:
 - i) Sign the Contract in accordance with ITT 50; or
 - ii) Furnish a performance security in accordance with ITT 51.

21.7 Where the Tender-Securing Declaration is executed the Procuring Entity will recommend to the PPRA that PPRA debars the Tenderer from participating in public procurement as provided in the law.

21.8 The Tender Security or the Tender-Securing Declaration of a JV shall be in the name of the JV that submits the Tender. If the JV has not been legally constituted into a legally enforceable JV at the time of tendering, the Tender Security or the Tender-Securing Declaration shall be in the names of all future members as named in the letter of intent referred to in ITT 4.1 and ITT 13.2.

21.9 A tenderer shall not issue a tender security to guarantee itself.

22 Format and Signing of Tender

22.1 The Tenderer shall prepare one original of the documents comprising the Tender as described in ITT 13 and clearly mark it "ORIGINAL." Alternative Tenders, if permitted in accordance with ITT 15, shall be clearly marked "ALTERNATIVE." In addition, the Tenderer shall submit copies of the Tender, in the number **specified in the TDS** and clearly mark them "COPY." In the event of any discrepancy between the original and the copies, the original shall prevail.

22.2 Tenderers shall mark as "CONFIDENTIAL" all information in their Tenders which is confidential to their business. This may include proprietary information, trade secrets, or commercial or financially sensitive information.

22.3 The original and all copies of the Tender shall be typed or written in indelible ink and shall be signed by a person duly authorized to sign on behalf of the Tenderer. This authorization shall consist of a written confirmation **as specified in the TDS** and shall be attached to the Tender. The name and position held by each person signing the authorization must be typed or printed below the signature. All pages of the Tender where entries or amendments have been made shall be signed or initialed by the person signing the Tender.

22.4 In case the Tenderer is a JV, the Tender shall be signed by an authorized representative of the JV on behalf of the JV, and so as to be legally binding on all the members as evidenced by a power of attorney signed by their legally authorized representatives.

22.5 Any inter-lineation, erasures, or overwriting shall be valid only if they are signed or initialed by the person signing the Tender.

D. Submission and Opening of Tenders

23 Sealing and Marking of tenders

23.1 The Tender shall deliver the Proposals (technical and Financial) in a single sealed envelope, or in a single sealed package, or in a single sealed container bearing the name and Reference number of the Tender addressed to the Procuring Entity and a warning "DO NOT OPEN BEFORE..... (the time and date for Tender opening date)". Within the single envelope, package or container, the Tenderer shall place the following separate, sealed envelopes:

23.2 In the single sealed envelope, or in a single sealed package, or in a single sealed container the following documents shall be closed and shall be addressed as follows:

- a. in an envelope or package or container marked "ORIGINAL", all documents comprising the Technical Proposal, and
- b. in an envelope or package or container marked "COPIES", all required copies of the Technical Proposal; and

- c. in an envelope marked “ORIGINAL” the Form of Tender(Financial Proposal); and The inner envelopes or packages or containers shall:
 - i. bear the name and address of the Procuring Entity.
 - ii. bear the name and address of the Tender; and
 - iii. bear the name and Reference number of the Contract.
- 23.3 If an envelope or package or container is not sealed and marked as required, the *Procuring Entity* will assume no responsibility for the misplacement or premature opening of the proposal. Tenders that are misplaced or opened prematurely will not be accepted.
- 23.4 The Proposal or its modifications must be sent to the address indicated in the **Data Sheet** and received by the Procuring Entity no later than the deadline indicated in the Data Sheet, or any extension to this deadline. Any Proposal or its modification received by the Procuring Entity after the deadline shall be declared late and rejected, and promptly returned unopened.

24 Deadline for Submission of Tenders

- 24.1 Tenders must be received by the Procuring Entity at the address **specified in the TDS** and no later than the date and time also **specified in the TDS**. **When so specified in the TDS**, Tenderers shall have the option of submitting their Tenders electronically. Tenderers submitting Tenders electronically shall follow the electronic Tender submission procedures **specified in the TDS**.
- 24.2 The Procuring Entity may, at its discretion, extend the deadline for the submission of Tenders by amending the Tender Documents in accordance with ITT 8, in which case all rights and obligations of the Procuring Entity and Tenderers previously subject to the deadline shall thereafter be subject to the deadline as extended.

25 Late Tenders

- 25.1 The Procuring Entity shall not consider any Tender that arrives after the deadline for submission of tenders, in accordance with ITT 24. Any Tender received by the Procuring Entity after the deadline for submission of Tenders shall be declared late, rejected, and returned unopened to the Tenderer.

26 Withdrawal, Substitution, and Modification of Tenders

- 26.1 A Tenderer may withdraw, substitute, or modify its Tender after it has been submitted by sending a written notice, duly signed by an authorized representative, and shall include a copy of the authorization in accordance with ITT 22.3, (except that withdrawal notices do not require copies). The corresponding substitution or modification of the Tender must accompany the respective written notice. All notices must be:
- a. prepared and submitted in accordance with ITT 22 and ITT 23 (except that withdrawals notices do not require copies), and in addition, the respective envelopes shall be clearly marked “WITHDRAWAL,” “SUBSTITUTION,” “MODIFICATION;” and
 - b. received by the Procuring Entity prior to the deadline prescribed for submission of Tenders, in accordance with ITT 22.
- 26.2 Tenders requested to be withdrawn in accordance with ITT 26.1 shall be returned unopened to the Tenderers.
- 26.3 No Tender may be withdrawn, substituted, or modified in the interval between the deadline for submission of Tenders and the expiration of the period of Tender validity specified by the Tenderer on the Form of Tender or any extension thereof.

27 Tender Opening

- 27.1 The Procuring Entity's opening committee shall conduct the opening of the Technical Proposals in the presence of the Tenders representatives who choose to attend. The opening date, time and the address are stated in the **TDS**. The envelopes with the Form of Tender (Financial Proposal) shall remain sealed and shall be securely stored by the Procuring Entity until they are opened.

- 27.2 At the opening of the Technical Proposals the following shall be read out: (i) the name and the country of the Tender or, in case of a Joint Venture, the name of the Joint Venture, the name of the lead member and the names and the countries of all members; (ii) the presence or absence of a duly sealed envelope of the Form of Tender (Financial Proposal); (iii) any modifications to the Proposal submitted prior to Tender submission deadline; and (iv) any other information deemed appropriate or as indicated in the **TDS**.
- 27.3 First, envelopes marked “WITHDRAWAL” shall be opened and read out and the envelopes with the corresponding Tender shall not be opened, but returned to the Tenderer. No Tender withdrawal shall be permitted unless the corresponding withdrawal notice contains a valid authorization to request the withdrawal and is readout at Tender opening.
- 27.4 Next, envelopes marked “SUBSTITUTION” shall be opened and read out and exchanged with the corresponding Tender being substituted, and the substituted Tender shall not be opened, but returned to the Tenderer. No Tender substitution shall be permitted unless the corresponding substitution notice contains a valid authorization to request the substitution and is readout at Tender opening.
- 27.5 Next, envelopes marked “MODIFICATION” shall be opened and read out with the corresponding Tender. No Tender modification shall be permitted unless the corresponding modification notice contains a valid authorization to request the modification and is readout at Tender opening.
- 27.6 Next, all remaining envelopes shall be opened one at a time, reading out: the name of the Tenderer and whether there is a modification; including any discounts and alternative Tenders; the presence or absence of a Tender Security or Tender-Securing Declaration, if required; and any other details as the Procuring Entity may consider appropriate.
- 27.7 Only Tenders, alternative Tenders and discounts that are opened and read out at Tender opening shall be considered further for evaluation.
- 27.8 At the Tender Opening, the Procuring Entity shall neither discuss the merits of any Tender nor reject any Tender (except for late Tenders, in accordance with ITT 25.1).
- 27.9 The Procuring Entity shall prepare minutes of the opening of technical proposals that shall include, as a minimum:
- a. the name of the Tenderer and whether there is a withdrawal, substitution, or modification; and any discounts offered as a separate letter;
 - b. presence of a sealed Form of Tender Price;
 - c. any alternative technical proposals, if any;
 - d. the presence or absence of a Tender Security, if one was required.
- 27.10 The Tenderers' representatives who are present shall be requested to sign the minutes. The omission of a Tenderer's signature on the minutes shall not invalidate the contents and effect of the minutes. A copy of the tender opening register shall be distributed to all Tenderers upon request.
- 27.11 After the technical evaluation is completed, the Procuring Entity shall notify those Tenderers whose Proposals were considered non-responsive to the Tender document for not meeting the minimum qualifying technical score, advising them the following: (i) their Proposal was not responsive to the Tender Document and did not meet the minimum qualifying technical score; (ii) provide information relating to the Tenderer's overall technical score, as well as scores obtained; (iii) their Forms of Tender will be returned unopened after completing the tender process and contract signing; and (iv) notify them of the date, time and location of the public opening of the Forms of Tender (Financial Proposals) and invite them to attend.
- 27.12 The opening date of the Forms of Tender should allow the Tenders sufficient time to decide for attending the opening and shall be not less than five (5) Business Days from the date of notification of the results of the technical evaluation. Tenderer's attendance at the opening of the Forms of Tender is optional and is at the Tenderer's choice. The Forms of Tender shall be opened publicly by the Procuring Entity's opening committee in the presence of the representatives of the Tenderers who chooses to attend.
- 27.13 At the opening, the names of the Tenders, and the overall technical scores, shall be read aloud. The Forms of Tender will then be inspected to confirm that they have remained sealed and unopened. These Forms of Tender shall be then opened, and the total prices read aloud and recorded. Upon request, copies of the record shall be sent to all Tenders who submitted Tenders.

E. Evaluation and Comparison of Tenders

28 Confidentiality

- 28.1 Information relating to the evaluation of Tenders and recommendation of contract award shall not be disclosed to Tenderers or any other persons not officially concerned with the Tender process until information on Intention to Award the Contract is transmitted to all Tenderers in accordance with ITT 44.
- 28.2 Any effort by a Tenderer to influence the Procuring Entity in the evaluation of the Tenders or Contract award decisions may result in the rejection of its tender.
- 28.3 Not with standing ITT 28.2, from the time of tender opening to the time of contract award, if a tenderer wishes to contact the Procuring Entity on any matter related to the tendering process, it shall do so in writing.

29 Clarification of Tenders

- 29.1 To assist in the examination, evaluation, and comparison of the tenders, and qualification of the tenderers, the Procuring Entity may, at its discretion, ask any tenderer for a clarification of its tender, given a reasonable time for a response. Any clarification submitted by a tenderer that is not in response to a request by the Procuring Entity shall not be considered. The Procuring Entity's request for clarification and the response shall be in writing. No change, including any voluntary increase or decrease, in the prices or substance of the tender shall be sought, offered, or permitted, except to confirm the correction of arithmetic errors discovered by the Procuring Entity in the evaluation of the tenders, in accordance with ITT 33.
- 29.2 If a tenderer does not provide clarifications of its tender by the date and time set in the Procuring Entity's request for clarification, its Tender may be rejected.

30 Deviations, Reservations, and Omissions

- 30.1 During the evaluation of tenders, the following definitions apply:

“Deviation” is a departure from the requirements specified in the tender document;

“Reservation” is the setting of limiting conditions or withholding from complete acceptance of the requirements specified in the tender document; and “Omission” is the failure to submit part or all of the information or documentation required in the Tender document.

31 Determination of Responsiveness

- 31.1 The Procuring Entity's determination of a Tender's responsiveness is to be based on the contents of the tender itself, as defined in ITT 13.
- 31.2 A substantially responsive Tender is one that meets the requirements of the Tender document without material deviation, reservation, or omission. A material deviation, reservation, or omission is one that, if accepted, would:
- Affect in any substantial way the scope, quality, or performance of the Works specified in the Contract; or
 - limit in any substantial way, inconsistent with the tender document, the Procuring Entity's rights or the tenderer's obligations under the proposed contract; or
 - if rectified, would unfairly affect the competitive position of other tenderers presenting substantially responsive tenders.
- 31.3 The Procuring Entity shall examine the technical aspects of the tender submitted in accordance with ITT 18, to confirm that all requirements of Section VII, Works' Requirements have been met without any material deviation, reservation or omission.
- 31.4 If a tender is not substantially responsive to the requirements of the tender document, it shall be rejected by the Procuring Entity and may not subsequently be made responsive by correction of the material deviation, reservation, or omission.

32 Non-material Non-conformities

- 32.1 Provided that a tender is substantially responsive, the Procuring Entity may waive any non-conformities in the tender.
- 32.2 Provided that a Tender is substantially responsive, the Procuring Entity may request that the tenderer submit the necessary information or documentation, within a reasonable period of time, to rectify nonmaterial non-conformities in the tender related to documentation requirements. Requesting information or documentation on such non-conformities shall not be related to any aspect of the price of the tender. Failure of the tenderer to comply with the request may result in the rejection of its tender.
- 32.3 Provided that a tender is substantially responsive, the Procuring Entity shall rectify quantifiable nonmaterial non-conformities related to the Tender Price. To this effect, the Tender Price shall be adjusted, for comparison purposes only, to reflect the price of a missing or non-conforming item or component in the manner specified **in the TDS.**
- 32.4 Provided that the tender is substantially responsive, no correction of errors is expected in this tender.

33 Correction of Arithmetical Errors

- 33.1 The tender sum as submitted and read out during the tender opening shall be absolute and final and shall not be the subject of correction, adjustment or amendment in any way by any person or entity.
- 33.2 Provided that the Tender is substantially responsive, the Procuring Entity shall handle errors on the following basis:
- a. Any error detected if considered a major deviation that affects the substance of the tender, shall lead to disqualification of the tender as non-responsive.
 - b. Any errors in the submitted tender arising from a miscalculation of unit price, quantity, subtotal and total bid price shall be considered as a major deviation that affects the substance of the tender and shall lead to disqualification of the tender as non-responsive. and
 - c. If there is a discrepancy between words and figures, the amount in words shall prevail, unless the amount expressed in words is related to an arithmetic error, in which case the amount in figures shall prevail.

34 Breakdown of the Tender Price

- 34.1 The completed Form of Tender shall have a table indicating the a detailed of the Tender Price which must include:
- a. Preliminary items such as insurance for works, noticeboards, statutory payments, site office costs, etc.,
 - b. Monthly cost of design/supervisory staff and site agents (up to contract completion);
 - c. Monthly cost of major items of equipment (up to contract completion);
 - d. Cost of the works (a lump sum figure).
 - e. Any items specified in the **TDS.**
- 34.2 The Breakdown of the Tender Price will form the basis of the Bills of Quantities and Payment Schedule and will be agreed with the Procuring Entity prior to signing of the contract and it will be part of the Contract Agreement. In addition, the Contract or shall be required to submit non-binding quarterly estimates of the payments which he expects to become due during the execution of the works.
- 34.3 In preparing the Schedule of Payments, every effort must be taken to ensure that the schedule is not is seriously unbalanced and/or front loaded. If in the Procuring Entity's opinion, the schedule is seriously unbalanced and/or front loaded, the Procuring Entity may require the Tenderer to provide written clarifications. Clarifications may include detailed price analyses to demonstrate the consistency of the schedule of prices with the scope of works, proposed methodology, schedule and any other requirements of the Contract.
- 34.4 On award of Contract, within the period specified in the **TDS**, the tenderer will prepare a complete Bills of Quantities for the works in conformity with ITT 31.1 (d) which will form the basis of preparing payment certificates. If in the Procuring Entity's opinion, the pricing in the Bills of Quantities is seriously unbalanced and/or front loaded, the Procuring Entity may require the Tenderer to provide written clarifications. Clarifications may include detailed price analyses to demonstrate the consistency of the schedule of prices

with the scope of works, proposed methodology, schedule and any other requirements of the Contract.

35 Conversion to Single Currency

35.1 For evaluation and comparison purposes, the currency (ies) of the Tender shall be converted into a single currency **as specified in the TDS**.

36 Margin of Preference and Reservations

36.1 A margin of preference may be allowed only when the contract is open to international competitive tendering where foreign contractors are expected to participate in the tendering process and where the contract exceeds the value/threshold specified in the Regulations.

36.2 A margin of preference shall not be allowed unless it is specified so in the **TDS**.

36.3 Contracts procured on basis of international competitive tendering shall not be subject to reservations exclusive to specific groups as provided in ITT36.1.

37 Nominated Subcontractors

37.1 **Unless** otherwise stated **in the TDS**, the Procuring Entity does not intend to execute any specific elements of the Works by subcontractors selected in advance by the Procuring Entity.

37.2 Tenderers may propose subcontracting up to the percentage of total value of contracts or the volume of works as specified **in the TDS**. Subcontractors proposed by the Tenderer shall be fully qualified for their parts of the Works.

37.3 The subcontractor's qualifications shall not be used by the Tenderer to qualify for the Works unless their specialized parts of the Works were previously designated by the Procuring Entity **in the TDS** as can be met by subcontractors referred to hereafter as 'Specialized Subcontractors', in which case, the qualifications of the Specialized Subcontractors proposed by the Tenderer may be added to the qualifications of the Tenderer.

38 Evaluation of Tenders

38.1 To assist in the examination, and evaluation of Technical Proposals, and qualification of the tenderers, the Procuring Entity may, at its discretion, ask any tenderer for a clarification of its Tender, given a reasonable time for a response. Any clarification submitted by a tenderer that is not in response to a request by the Procuring Entity shall not be considered. The Procuring Entity's request for clarification and the response shall be in writing. No change, including any voluntary increase or decrease, in the prices or substance of the tender shall be sought, offered, or permitted, except to confirm the correction of any errors discovered by the Procuring Entity in the evaluation of the tenders, in accordance with ITT 33.

38.2 If a tenderer does not provide clarifications of its tender by the date and time set in the Procuring Entity's request for clarification, its Tender may be rejected.

38.3 The Procuring Entity's evaluation committee shall evaluate the Technical Proposals that have passed the eligibility and mandatory criteria, on the basis of their responsiveness to the Tender Documents. The eligibility and mandatory criteria shall include the following and any other that may include in the **Data sheet**.

- a) Firm has submitted the required number of copies of the Technical Proposals.
- b) Firm has submitted a sealed form of Tender (Financial proposal).
- c) The Proposal is valid for the required number of days.
- d) The Technical Proposal is signed by the person with power of attorney, without material deviation, reservation, or omission.
- e) The Technical Proposal is complete with all the forms and required documentary evidence submitted.
- f) Valid Tax Compliance Certificate for Kenyan firms.
- g) Key Experts are from eligible countries.
- h) A tenderer has not participated in more than one tender, except for alternative tenders if so allowed.
- i) The tender is not in solvent, in receivership, bankrupt or in the process of being wound up.

- j) The Tenderer, its sub-consultants and experts have not engaged in or been convicted of corrupt or fraudulent practices.
 - k) The Tenderer is neither precluded from entering into a Contract nor debarred by PPRA.
 - l) The Tenderer has not proposed employing public officials, civil servants and employees of public institutions.
 - m) The Tenderer, its sub-consultants and experts have no conflicts of interest.
 - n) Any other material requirement in the ITT.
- 38.4 Only Technical proposals of tenderers that pass the preliminary examination will be evaluated. A Proposal shall be rejected at this stage if it does not respond to important aspects of the tender document if it fails to achieve the minimum technical score indicated in the **TDS**.

39 Comparison of Tender Prices

- 39.1 The Procuring Entity shall use the criteria and methodologies listed in the ITT and Section III, Evaluation and Qualification Criteria. No other evaluation criteria or methodologies shall be permitted. By applying the criteria and methodologies the Procuring Entity shall determine the Lowest Evaluated Tender in accordance with ITT 40.
- 39.2 To evaluate a Tender, the Procuring Entity shall consider the following:
- a) The Tender price, including Provisional Sums, if any;
 - b) Price adjustment due to unconditional discounts offered in accordance with ITT 16.4;
 - c) converting the amount resulting from applying (a) to (c) above, if relevant, to a single currency in accordance with ITT 35;
 - d) any additional evaluation factors specified **in the TDS** and Section III, Evaluation and Qualification Criteria.
- 39.3 The estimated effect of the price adjustment provisions of the Conditions of Contract, applied over the period of execution of the Contract, shall not be considered in Tender evaluation.
- 39.4 In the case of multiple contracts or lots, Tenderers are allowed to tender for one or more lots and the methodology to determine the lowest evaluated cost of the lot (contract) and for combinations, including any discounts offered in the Form of Tender, is specified in Section III, Evaluation and Qualification Criteria.
- 39.5 The Procuring Entity shall compare the evaluated costs of all substantially responsive Tenders established in accordance with ITT 38.2 to determine the Tender that has the lowest evaluated cost.

40 Abnormally Low Tenders

- 40.1 An Abnormally Low Tender is one where the Tender price, in combination with other elements of the Tender, appears so low that it raises material concerns as to the capability of the Tenderer in regards to the Tenderer's ability to perform the Contract for the offered Tender Price.
- 40.2 In the event of identification of a potentially Abnormally Low Tender, the Procuring Entity shall seek written clarifications from the Tenderer, including detailed price analyses of its Tender price in relation to the subject matter of the contract, scope, proposed methodology, schedule, allocation of risks and responsibilities and any other requirements of the Tender document.
- 40.3 After evaluation of the price analyses, in the event that the Procuring Entity determines that the Tenderer has failed to demonstrate its capability to perform the Contract for the offered Tender Price, the Procuring Entity shall reject the Tender.

41 Abnormally High Tenders

- 41.1 An abnormally high tender price is one where the tender price, in combination with other constituent elements of the Tender, appears unreasonably too high to the extent that the Procuring Entity is concerned that it (the Procuring Entity) may not be getting value for money or it may be paying too high a price for the contract compared with market prices or that genuine competition between Tenderers is compromised.
- 41.2 In case of an abnormally high price, the Procuring Entity shall make a survey of the market prices, check if

the estimated cost of the contract is correct and review the Tender Documents to check if the specifications, scope of work and conditions of contract are contributory to the abnormally high tenders. The Procuring Entity may also seek written clarification from the tenderer on the reason for the high tender price. The Procuring Entity shall proceed as follows:

- i) If the tender price is abnormally high based on wrong estimated cost of the contract, the Procuring Entity may accept or not accept the tender depending on the Procuring Entity's budget considerations.
- ii) If specifications, scope of work and/or conditions of contract are contributory to the abnormally high tender prices, the Procuring Entity shall reject all tenders and may retender for the contract based on revised estimates, specifications, scope of work and conditions of contract, as the case may be.

41.3 If the Procuring Entity determines that the Tender Price is abnormally too high because genuine competition between tenderers is compromised (*often due to collusion, corruption or other manipulations*), the Procuring Entity shall reject all Tenders and shall institute or cause competent Government Agencies to institute an investigation on the cause of the compromise, before retendering.

42 Qualifications of the Tenderer

42.1 The Procuring Entity shall determine to its satisfaction whether the eligible Tenderer that is selected as having submitted the lowest evaluated cost and substantially responsive Tender, meets the qualifying criteria specified in Section III, Evaluation and Qualification Criteria.

42.2 The determination shall be based upon an examination of the documentary evidence of the Tenderer's qualifications submitted by the Tenderer, pursuant to ITT 19. The determination shall not take into consideration the qualifications of other firms such as the Tenderer's subsidiaries, parent entities, affiliates, subcontractors (other than Specialized Subcontractors if permitted in the Tender document), or any other firm (s) different from the Tenderer.

42.3 An affirmative determination shall be a prerequisite for award of the Contract to the Tenderer. A negative determination shall result in disqualification of the Tender, in which event the Procuring Entity shall proceed to the Tenderer who offers a substantially responsive Tender with the next lowest evaluated price to make a similar determination of that Tenderer's qualifications to perform satisfactorily.

43 Lowest Evaluated Tender

43.1 Having compared the evaluated prices of Tenders, the Procuring Entity shall determine the Lowest Evaluated Tender. The Lowest Evaluated Tender is the Tender of the Tenderer that meets the Qualification Criteria and whose Tender has been determined to be:

- a) Substantially responsive to the Tender document; and
- b) The lowest evaluated price.

44 Procuring Entity's Right to Accept Any Tender, and to Reject Any or All Tenders.

The Procuring Entity reserves the right to accept or reject any Tender and to annul the Tender process and reject all Tenders at any time prior to Contract Award, without there by incurring any liability to Tenderers. In case of annulment, all Tenders submitted and specifically, Tender securities, shall be promptly returned to the Tenderers.

F. AWARD OF CONTRACT

45 Award Criteria

The Procuring Entity shall award the Contract to the successful tenderer whose tender has been determined to be the Lowest Evaluated Tender.

46 Notice of Intention to enter into a Contract/Notification of award

46.1 Upon award of the contract and Prior to the expiry of the Tender Validity Period the Procuring Entity shall issue a Notification of Intention to Enter into a Contract/Notification of award to all tenderers which shall contain, at a minimum, the following information:

- a. The name and address of the Tenderer submitting the successful tender;
- b. The Contract price of the successful tender;

- c. a statement of the reason(s) the tender of the unsuccessful tenderer to whom the letter is addressed was unsuccessful, unless the price information in (c) above already reveals the reason;
- d. the expiry date of the Standstill Period; and
- e. instructions on how to request a debriefing and/or submit a complaint during the standstill period;

47 Standstill Period

- 47.1 The Contract shall not be signed earlier than the expiry of a Standstill Period of 14 days to allow any dissatisfied tender to launch a complaint. Where only one Tender is submitted, the Standstill Period shall not apply.
- 47.2 Where a Standstill Period applies, it shall commence when the Procuring Entity has transmitted to each Tenderer the Notification of Intention to Enter in to a Contract with the successful Tenderer.

48 Debriefing by the Procuring Entity

- 48.1 On receipt of the Procuring Entity's Notification of Intention to Enter in to a Contract referred to in ITT 46, an unsuccessful tenderer may make a written request to the Procuring Entity for a debriefing on specific issues or concerns regarding their tender. The Procuring Entity shall provide the debriefing within five days of receipt of the request.
- 48.2 Debriefings of unsuccessful Tenderers may be done in writing or verbally. The Tenderer shall bear its own costs of attending such a debriefing meeting.

49 Letter of Award

- 49.1 Prior to the expiry of the Tender Validity Period and upon expiry of the Standstill Period specified in ITT 44.1, upon addressing a complaint that has been filed within the Standstill Period, the Procuring Entity shall transmit the Letter of Award to the successful Tenderer. The letter of award shall request the successful tenderer to furnish the Performance Security within 21 days of the date of the letter.

50 Signing of Contract

- 50.1 Upon the expiry of the fourteen days of the Notification of Intention to enter into contract and upon the parties meeting their respective statutory requirements, the Procuring Entity shall send the successful Tenderer the Contract Agreement.
- 50.2 Within fourteen (14) days of receipt of the Contract Agreement, the successful Tenderer shall sign, date, and return it to the Procuring Entity.
- 50.3 The written contract shall be entered into within the period specified in the notification of award and before expiry of the tender validity period
- 50.4 Notwithstanding ITT 50.2 above, in case signing of the Contract Agreement is prevented by any export restrictions attributable to the Procuring Entity, to Kenya, or to the use of the Information System to be supplied,
- 50.5 Where such export restrictions arise from trade regulations from a country supplying those Information System, the Tenderer shall not be bound by its Tender, provided that the Tenderer can demonstrate that signing of the Contract Agreement has not been prevented by any lack of diligence on the part of the Tenderer in completing any formalities, including applying for permits, authorizations and licenses necessary for the export of the Information System under the terms of the Contract.

51 Performance Security

- 51.1 Within twenty-one (21) days of the receipt of the Letter of Acceptance from the Procuring Entity, the successful Tenderer shall furnish the Performance Security and, any other documents required in the **TDS**, in accordance with the General Conditions of Contract, subject to ITT 38.2 (b), using the Performance Security and other Forms included in Section X, Contract Forms, or another form acceptable to the Procuring Entity. A foreign institution providing a bank guarantee shall have a correspondent financial institution located in Kenya, unless the Procuring Entity has agreed in writing that a correspondent bank is not required.

- 51.2 Failure of the successful Tenderer to submit the above-mentioned Performance Security and other documents required in the **TDS**, or sign the Contract shall constitute sufficient grounds for the annulment of the award and forfeiture of the Tender Security. In that event the Procuring Entity may award the Contract to the Tenderer offering the next Lowest Evaluated Tender.
- 51.3 Performance security shall not be required for contracts estimated to cost less than Kenya shillings five million shillings.

52 Publication of Procurement Contract

Within fourteen days after signing the contract, the Procuring Entity shall publish the awarded contract at its notice boards and websites; and on the Website of the Authority. At the minimum, the notice shall contain the following information:

- a) Name and address of the Procuring Entity;
- b) name and reference number of the contract being awarded, a summary of its scope and the selection method used;
- c) the name of the successful Tenderer, the final total contract price, the contract duration.
- d) Dates of signature, commencement and completion of contract;
- e) Names of all Tenderers that submitted Tenders, and their Tender prices as read out at Tender opening.

53 Procurement Related Complaint and Administrative Review

- 53.1 The procedures for making Procurement-related Complaints or a request for review shall be specified in the **TDS**.
- 53.2 A request for administrative review shall be made in the form provided under contract forms.

SECTION II - TENDER DATA SHEET (TDS)

The following specific data shall complement, supplement, or amend the provisions in the Instructions to Tenderers (ITT). Whenever there is a conflict, the provisions herein shall prevail over those in ITT.

Reference to ITC Clause	PARTICULARS OF APPENDIX TO INSTRUCTIONS TO TENDERS
A. General	
ITT 1.1	<p>The reference number of the Invitation to Tender (ITT) is: <u>TENDER NO: KBI/IFT/OIT/001/2023-2024</u> <u>W.P. ITEM NO. D1081 NB/NB/2301 JOB NO. 11221A</u></p> <p>The Procuring Entity is: Kenya Biovax Institute Limited</p> <p>The name of the ITT is: Design, Build, Assemble, Install, Commission, Training and Maintenance of Enabling Works of a GMP-Certified, ‘Fill – And – Finish’, Turn-Key Sterile Biomanufacturing Facility</p> <p>The number and identification of lots (contracts) comprising this ITT is:</p> <ul style="list-style-type: none"> a) <i>Lot 1</i> : Design, Supply & Installation of Vaccine Bio-Waste Kill System; b) <i>Lot 2</i> : Design, Supply & Installation of Effluent Treatment Plant (ETP); c) <i>Lot 3</i> : Drilling & Equipping Borehole; d) <i>Lot 4</i> : Design, Supply & Installation of Water Treatment Plant e) <i>Lot 5</i> : Design and Build of Associated Civil & Builders Works f) <i>Lot 6</i> : Concept & detail Design of Fill & Finish Vaccine line;
ITT 2.3	The firm that provided consulting services for the contract being tendered for are: <i>State Department for Public Works</i>
ITT 3.1	Maximum number of members in the Joint Venture (JV) shall be: Three (3) . If the Joint Ventures includes a Consortium, the Tenderer/bidder must state Clearly and attach documentation
B. Contents of Tender Document	
ITT 8.1	<p>A. The procuring entity shall hold a pre-tender conference and a site visit and issue site visit certificate as follows;</p> <p>Date: 23rd January 2024 & 30th January 2024</p> <p>Time: 11:00Am (EAT)</p> <p>Place: Kenya Biovax Institute Limited Headquarters, BioVax Premises, Rd to Utawala Academy, Embakasi</p>
ITT 8.2	Any questions in writing, shall reach the Procuring Entity not later than 5 working days before the Tender Opening Date.
ITT 8.4	Minutes of the pre-Tender meeting and the pre-arranged pretender visit of the site of the works will be published at the website.
ITT 9.1	<p>For Clarification of Tender purposes and for obtaining further information, the Procuring Entity’s address is:</p> <p>Name Kenya Biovax Institute Limited Physical Location BioVax Premises, Rd to Utawala Academy, Embakasi Address P.O. Box 40779 – 00100 Nairobi, Kenya. Phone +254-20-2719008 +254-775751639</p>

Reference to ITC Clause	PARTICULARS OF APPENDIX TO INSTRUCTIONS TO TENDERS
	Website www.biovax.go.ke Email procurement@biovax.go.ke/ info@biovax.go.ke
C. Preparation of Tenders	
ITT 13.1(h)	The Tenderer shall submit the following additional documents in its Tender: Equipment Data Sheet for Lots 1, 2, 3 ,4 & 5
ITT 15.1	Alternative Tenders shall not be considered.
ITT 15.2	Alternatives to the Time Schedule shall not be permitted.
ITT 15.4	Alternative technical solutions shall not be permitted.
ITT 16.5	The prices quoted by the Tenderer shall be eligible for adjustment as per PPADA 2015/ Section13
ITT 17.2.2	The rates of exchange shall be those published by Central Bank of Kenya as on the date 17 th Jan 2024
ITT 20.1	The Tender validity period shall be 154 days.
ITT 21.1	A Tender Security Ksh 5,000,000.00 is required. A Tender-Securing Declaration Shall not be required.
ITT 22.1	In addition to the original of the Technical and Financial Proposal, the number of copies is: One
ITT 22.3	The written confirmation of authorization to sign on behalf of the Tenderer shall consist of: The written confirmation of authorization to sign on behalf of the Tenderer shall consist of: Written power of attorney/Authorization letter
D. Submission and Opening of Tenders	
ITT 23.2	Tenderer to submit Technical Proposal and Financial Proposal . The dully filled, signed and stamped Form of Tender will be contained in the Financial Proposal
ITT 24.1	For <u>Tender submission purposes</u> only, the Procuring Entity’s address is: Attention Name The CEO/ Director General Kenya BioVax Institute Limited Physical Address BioVax Premises, Rd to Utawala Academy, Embakasi Address P.O. Box 40779 – 00100 Nairobi, Kenya. Phone +254-20-2719008 Cell +254-775751639 Information on the outer envelope should also include: Tender Name and Ref. No The deadline for Tender submission is: Date: 23rd February 2024 Time: 11:00Am (EAT)
ITT 24.1	Tenderers are not allowed to submit Tenders electronically.

Reference to ITC Clause	PARTICULARS OF APPENDIX TO INSTRUCTIONS TO TENDERS
ITT 27.1	<p>The Tender opening shall take place at the time and the address for Opening of Tenders provided below:</p> <p>Name Kenya Biovax Institute Limited</p> <p>Physical Address BioVax Premises, Rd to Utawala Academy, Embakasi</p> <p>Date: 23rd February 2024</p> <p>Time: 11:00 am (EAT)</p>
E. Evaluation, and Comparison of Tenders	
ITT 32.3	<p>The Procuring Entity shall rectify quantifiable nonmaterial nonconformities related to the Tender Price in the following manner:</p> <p>The adjustment shall be based on the <i>highest</i> price of the item or component as quoted in other substantially responsive Tenders. If the price of the item or component cannot be derived from the price of other substantially responsive Tenders, the Procuring Entity shall use its best estimate.</p>
ITT 34.1 (e)	Any items specified in the Breakdown of the Tender Price (specify and list) N/A
ITT 34.4	The Contractor will prepare a complete Bills of Quantities for the work within 21 days after award of Contract.
ITT 35.1	<p>The currency that shall be used for Tender evaluation and comparison purposes to convert at the selling exchange rate all Tender prices expressed in various currencies into a single currency is: Kenya Shillings</p> <p>The source of exchange rate shall be: The Central bank of Kenya</p> <p>The date for the exchange rate shall be: the deadline date for Submission of the Tenders.</p>
ITT 37.1	At this time, the Procuring Entity <i>does not intend</i> to execute certain specific parts of the Works by subcontractors selected in advance.
ITT 37.1	Contractor's may propose subcontracting: Maximum percentage of subcontracting permitted is: <i>10% of the total contract amount</i> . Tenderers planning to subcontract more than 10% of total volume of work shall specify, in the Form of Tender, the activity (ies) or parts of the Works to be subcontracted along with complete details of the subcontractors and their qualification and experience.
ITT 37.1	<p>The parts of the Works for which the Procuring Entity permits Tenderers to propose Specialized Subcontractors are designated as follows:</p> <p>a) Lot 1 : <i>Design, Supply & Installation of Vaccine Bio-Waste Kill System;</i></p> <p>b) Lot 2 : <i>Design, Supply & Installation of Effluent Treatment Plant (ETP);</i></p> <p>c) Lot 3 : <i>Drilling & Equipping Borehole;</i></p> <p>d) Lot 4 : <i>Design, Supply & Installation of Water Treatment Plant</i></p> <p>e) Lot 5 : <i>Design and Build of Associated Civil & Builders Works</i></p> <p>f) Lot 6 : <i>Concept & detail Design of Fill & Finish Vaccine line;</i></p> <p>For the above-designated parts of the Works that may require Specialized Subcontractors, the relevant qualifications of the proposed Specialized Subcontractors will be added to the</p>

Reference to ITC Clause	PARTICULARS OF APPENDIX TO INSTRUCTIONS TO TENDERS
	qualifications of the Tenderer for the purpose of evaluation.
ITT 37.2	The qualifications of the Specialized Subcontractors proposed by the Tenderer may be added to the qualifications of the Tenderer.
ITT 38.4	A Proposal shall be rejected if it attains a FAIL in any of the requirement.
ITT 39.2(d)	Additional requirements apply. These are detailed in the evaluation criteria in Section III, Evaluation and Qualification Criteria.
ITT 39.4	Tenderers shall quote for ALL LOTS (CONTRACTS) and the methodology to determine the lowest tenderer is specified in Section III, Evaluation and Qualification Criteria.
ITT 51.2	Performance Security ; other documents required are, list: 10% of the contract sum upon award
ITT 53.1	<p>The procedures for making a Procurement-related Complaint are detailed in the “Notice of Intention to Award the Contract” herein and are also available from the PPRA website www.ppra.go.ke.</p> <p>If a Tenderer wishes to make a Procurement-related Complaint, the Tenderer should submit its complaint following these procedures, in writing (by the quickest means available, that is either by hand delivery or email to:</p> <p>For the attention:</p> <p>Title/position: The Director General/CEO</p> <p>Procuring Entity: Kenya Biovax Institute Limited</p> <p>Email address: ceo@biovax.go.ke, and copy to procurement@biovax.go.ke</p> <p>In summary, a Procurement-related Complaint may challenge any of the following:</p> <ol style="list-style-type: none"> 1. the terms of the Tendering Documents; and <p>the Procuring Entity’s decision to award the contract</p>

SECTION III - EVALUATION AND QUALIFICATION CRITERIA

1. General Provisions

- 1.1 This section contains the criteria that the Procuring Entity shall use to evaluate tender and qualify tenderers. No other factors, methods or criteria shall be used other than specified in this tender document. The Tenderer shall provide all the information requested in the forms included in Section IV, Tendering Forms. The Procuring Entity shall use **the Standard Tender Evaluation Document for Goods and Works** for evaluating Tenders.
- 1.2 Wherever a Tenderer is required to state a monetary amount, Tenderers should indicate the Kenya Shilling equivalent using the rate of exchange determined as follows:
- For construction turn over or financial data required for each year -Exchange rate prevailing on the last day of the respective calendar year (in which the amounts for that year is to be converted) was originally established.
 - Value of single contract- Exchange rate prevailing on the date of the contract signature.
 - Exchange rates shall be taken from the publicly available source identified in the ITT. Any error in determining the exchange rates in the Tender may be corrected by the Procuring Entity.

1.3 Evaluation and contract award Criteria

The Procuring Entity shall use the criteria and methodologies listed in this Section to evaluate tenders and arrive at the Lowest Evaluated Tender. The tender that (i) meets the qualification criteria, (ii) has been determined to be substantially responsive to the Tender Documents, and (iii) is determined to have the Lowest Evaluated Tender price shall be selected for award of contract.

2. Preliminary examination for Determination of Responsiveness

The Procuring Entity will start by examining all tenders to ensure they meet in all respects the eligibility criteria and requirements in the ITT35.3, and that the tender is complete in all aspects in meeting the requirements of “Part 2 – Procuring Entity's Works Requirements”. Tenders that do not submit a Financial offer will also be rejected at this stage. The Standard Tender Evaluation Report Document for Goods and Works for evaluating Tenders provides clear guide on how to deal with review of these requirements. Tenders that do not pass the Preliminary Examination will be considered irresponsive and will not be considered further.

PRELIMINARY EVALUATION CRITERIA

S/NO.	MANDATORY REQUIREMENT	REMARKS (PASS/FAIL)
MR 1	Company Registration Certificate in the Country of Origin	
MR 2	A Technical Proposal submitted together with a Financial Proposal in separate envelopes	
MR 3	Tax Compliance Certificate or Equivalent	
MR 4	Certified Copy of recent CR12 Form or Equivalent issued not earlier than 6 Months from tender closing date.	
MR 5	Firm has submitted the required number of copies which 1 No. Original and 1 No. Copy	
MR 6	The tenderer's eligibility- confidential business questionnaire form properly filled dated and stamped.	
MR 7	Signed and stamped statement of Verification that not debarred in matters of public procurement proceedings self-declaration form SD1 (non-debarment form)	
MR 8	Declaration that The Tenderer, its sub-consultants and experts have not engaged in or been convicted of corrupt or fraudulent practices- FORM SD2	
MR 9	The Declaration and Commitment to the Code of Ethics form properly filled dated and stamped	

MR 10	Dully filled, signed and stamped Form CON-2 indicating Historical Contract Non-Performance, Pending Litigation and Litigation History	
MR 11	Dully filled ,dated and stamped Certificate of Independent Tender Determination	
MR 13	MUST submit tender security of Ksh. 5,000,000.00	
MR 14	Site Visit Certificate issued at Pre-tender conference	
MR 15	In case of a Consortium or Joint Venture, attach a duly filled and stamped agreement with Authorized Power of Attorney	
	OVERALL REMARKS	RESPONSIVE/ NONRESPONSIVE

Note:

The employer/procuring entity may seek further clarification/confirmation if necessary to confirm authenticity/compliance of any condition of the tender. Further, in case of a discrepancy between the amounts stated in the appendix to instruction to tenderers and the one stated in the advertisement or invitation letter, the bid security shall be taken as the amount in the advertisement/ letter of invitation.

The tenderers who do not satisfy any of the above requirements shall be considered non- Responsive and their tenders will not be evaluated further.

3. Evaluation of the Technical Proposal

Technical Proposal shall be comprised of the Design Proposals for the Works and other forms as called for in Section IV, Tendering Forms. The Procuring Entity shall then consider the Technical Proposal of the Tenders who have been found responsive. The Procuring Entity shall allocate scores for each criterion on the Table of Scores below. The Procuring Entity will evaluate the Technical Proposals of all tenders that pass Preliminary examination for Determination of Responsiveness using the following criteria and scoring system as indicated below. This is to ensure that the Procuring Entity opens and considers and opens Financial Proposals of proposals that the threshold score of the Technical Proposal.

S/No	Description of items as they relate to whole of works	Scores (to be allocated by the Procuring Entity)
1	Key Experts(both design and implementation)	PASS/FAIL
2	Participation by Kenyan citizens among proposed Key Experts (Kenyans 70% and Foreigners 30%)	PASS/FAIL
3	Specific experience of the firm in Bio Pharmaceutical projects	PASS/FAIL
4	Work Program and schedule	PASS/FAIL
5	Design methodology i.e., concept designs	PASS/FAIL
6	Construction methodology and management	PASS/FAIL
7	Evidence of Financial Resources	PASS/FAIL
8	Technical Capacity	PASS/FAIL
	OVERALL REMARKS	<u>PASS/FAIL</u>

The detailed Assessment for Eligibility shall be as shown in table 2 below: -

TABLE 2: Assessment for Eligibility

Item	Description	Remarks
1 A	Key Expert Personnel: Developer/Consortium Project Leadership Team (Attach evidence, Permits and provide copies of C. Vs)	
i	GMP Expert Consultant: Demonstrate successful leadership in driving overall execution of strategy and implementation with respect to bio pharmaceutical projects Holder of degree with over 20 years' relevant Experience	
ii	Operations Lead/Liaison Office: Demonstrate leadership in coordinating and executing the technical operations of the teams across the Project Management function of the contractors and consultants' teams as chief liaison officer between Contracting Authority and Project Manager Holder of degree with over 15 years' relevant Experience	
1 B	Key Expert Personnel: Contractors Technical Management General qualification and experience of key personnel. Attach copies of C. Vs and certificates).	
a	Project Manager	
	Masters in Engineering or Relevant field. Duly registered with the relevant professional bodies <ul style="list-style-type: none"> with At least 10 years' experience. 	
b	Architect	
	Bachelor's Degree in architecture with experience in the relevant field. Duly registered with BORAQS or equivalent <ul style="list-style-type: none"> with At least 7 years' experience. 	
c	Electrical Engineer	
	Bachelor's Degree in Electrical Engineering with experience in the relevant field. Duly registered with EBK, Corporate Member or Fellow with IEK or equivalent <ul style="list-style-type: none"> with At least 7 years' experience. 	
d	Mechanical Engineer	
	Bachelor's Degree in Mechanical Engineering with experience in the relevant field. Duly registered with EBK, Corporate Member or Fellow with IEK or equivalent <ul style="list-style-type: none"> with At least 7 years' experience. 	
e	GMP Expert	
	Bachelor's Degree in Biomedical Science field from an accredited institution. Shall have experience in quality department. Ideally working on an international scale in sterile pharmaceutical processing within GMP standards <ul style="list-style-type: none"> with At least 5 years' experience. 	
f	Quantity Surveyor	
	Bachelor's Degree in Quantity surveying with experience in the relevant field. Duly registered with BORAQS or equivalent <ul style="list-style-type: none"> with At least 7 years' experience. 	
g	Civil/Structural Engineer	
	Bachelor's Degree in Civil/Structural Engineering with experience in the relevant field. Duly registered with EBK, Corporate Member or Fellow with IEK or equivalent <ul style="list-style-type: none"> with At least 7 years' experience. 	

h	Environmental Impact Assessment Expert	
	Bachelor's Degree in Environmental Science or equivalent with experience in Bio pharmaceutical industry <ul style="list-style-type: none"> with At least 5 years' experience. 	
i	Occupational Safety and Health Administration Expert Bachelor's Degree in science, engineering or medicine, and at least a postgraduate diploma in OSH, or a degree in OSH or equivalent with experience in Bio pharmaceutical industry <ul style="list-style-type: none"> with At least 5 years' experience. 	
2	The Tenderer to provide proof and justification on the Participation by Kenyan citizens among proposed Key Experts in term of the percentages highlighted (Kenya 70% and Foreign 30%)	
3	Completed Relevant Projects in the last 5years. Provide Evidence (Attach Award letter, Contract Agreement and Completion Certificate) At least 2 No. Bio Pharma projects of similar magnitude	
4	Work Program and schedule: The Tenderer shall attach Delivery Period/Work plan schedule in a gant chatt for undertaking the assignment from the design stage to the implementation stage (Submit sufficient details that demonstrate the Critical path and Lead Time of the LOT 1 with regards to the completion time referred to in Special Conditions of Contract)	
5	Design methodology: The methodology shall contain and demonstrate amongst others the following elements. (The client acknowledges that different types and forms of concept designs can approached to meet the ASK of this Tender and we welcome bidder creativity and flexibility;)	
a	Provide a summary statement of the proposed project design, explain the reasons behind the approach used and advantages there in.	
b	Strategies for achieving the successful end product as prescribed by the scope.	
6	Construction methodology and management: The Tenderer shall highlight the approach and management in the implementation of the Construction stage in the project.	
7.	Financial Resources	
a	Attach Audited financial report (last three 3years) (Signed and Stamped by Auditors)2022,2021,2020	
b	A letter from Bank submitting the Bank details	
c	Access to liquidity: Evidence of Other Financial Resources (Letters of access to credit specific to the tender, over draft facility etc.) Credit line shall be sufficient to complete the project bid price	
8	Technical Compliance with All LOTS: The Tenderer shall ensure compliance with the technical specifications highlighted in the Scope of the document for all the LOTS in the designs submitted	

TECHNICAL EVALUATION CRITERIA FOR SPECIALISTS' WORKS

S/NO.	MANDATORY REQUIREMENT	REMARKS (PASS/FAIL)
LOT 1 - Design, Supply & Installation of Vaccine Bio-Waste Kill System		
MR-L1-1	Data Sheet/Catalogue of Kill Tank	
LOT 2 - Supply & Installation of Effluent Treatment Plant (ETP);		
MR-L1-1	Data Sheet /Catalogue of Effluent Treatment Plant	
LOT 3 - Drilling & Equipping Borehole;		
MR-L1-1	Data Sheet/Catalogue of Borehole critical equipment	
LOT 4 - Design Supply & Installation of Water Treatment Plant;		
MR-L1-1	Data Sheet/Catalogue of Water Treatment Plant	
LOT 5 - Design and Build of Associated Civil & Builders Works		
	Designs of Builders ,Civil, Mechanical & Electrical works	
	National Construction Authority (NCA 5) and above classification or equivalent	
LOT 6- Concept & detail Design of Fill & Finish Vaccine line		
	Concept & detail Design of Fill & Finish Vaccine line	

3.4 A proposal shall be rejected at this stage if it does not respond to important aspects of the Terms of Reference or if it fails . Financial Proposals shall be opened for firms attaining a **PASS/RESPONSIVE**

4. Tender Evaluation (ITT 35)

Price evaluation: in addition to the criteria listed in ITT 36.2 (a) – (d) the following criteria shall apply:

- (i) **Alternative Completion Times**, if permitted under ITT 13.2, will be evaluated as follows:
.....
- (ii) **Alternative Technical Solutions** for specified parts of the Works, if permitted under ITT 13.4, will be evaluated as follows:
- (iv) **Other Criteria**; if permitted under ITT 36.2(e):
.....

5. Multiple Contracts

Multiple contracts will be permitted in accordance with ITT 36.4. Tenderers are evaluated on basis of Lots and the lowest evaluated tenderer identified for each Lot. The Procuring Entity will select one Option of the two Options listed below for award of Contracts.

6. Alternative Tenders (ITT 13.1)

An alternative if permitted under ITT 13.1, will be evaluated as follows:

The Procuring Entity shall consider Tenders offered for alternatives as specified in Part 2- Procuring Entity's requirements. Only the technical alternatives, if any, of the Tenderer with the Best Evaluated Tender conforming to the basic technical requirements shall be considered by the Procuring Entity.

7. MARGIN OF PREFERENCE

Apply Margin of Preference, if so allowed to all evaluated and accepted tender as follows.

- 7.1 If the TDS so specifies, the Procuring Entity will grant a margin of preference of fifteen percent (15%) to be loaded on evaluated prices of the foreign tenderers, where the percentage of shareholding of Kenyan citizens on the entire consortium team is less than fifty-one percent (51%).
- 7.2 Contractors applying for such preference shall be asked to provide, as part of the data for qualification, such information, including details of ownership, as shall be required to determine whether, according to the classification established by the Procuring Entity, a particular contractor or group of contractors qualifies for a margin of preference.
- 7.3 After Tenders have been received and reviewed by the Procuring Entity, responsive Tenders shall be assessed to ascertain their percentage of shareholding of Kenyan citizens. Responsive tenders shall be classified into the following groups:
 - i) Group A: tenders offered by Kenyan Contractors and other Tenderers where percentage of shareholding by Kenyan citizens on the entire consortium team is less than fifty-one percent (51%), where Kenyan citizens hold shares of over fifty one percent (51%).
 - ii) Group B: tenders offered by foreign Contractors and other Tenderers where percentage of shareholding by Kenyan citizens on the entire consortium team is less than fifty-one percent (51%).
- 7.4 All evaluated tenders in each group shall, as a first evaluation step, be compared to determine the lowest tender, and the lowest evaluated tender in each group shall be further compared with each other. If, as a result of this comparison, at tender from Group A is the lowest, it shall be selected for the award. If a tender from Group B is the lowest, an amount equal to the percentage indicated in Item 3.1 of the respective tender price, including unconditional discounts and excluding provisional sums and the cost of day works, if any, shall be added to the evaluated price offered in each tender from Group B. All tenders shall then be compared using new prices with added prices to Group B and the lowest evaluated tender from Group A. If the tender from Group A is still the lowest tender, it shall be selected for award. If not, the lowest evaluated tender from Group B based

on the first evaluation price shall be selected.

8. Post qualification and Contract award (ITT39), more specifically,

- a) In case the tender was subject to post-qualification, the contract shall be awarded to the lowest evaluated tenderer, subject to confirmation of prequalification data, if so required.
- b) In case the tender was not subject to post-qualification, the tender that has been determined to be the lowest evaluated tenderer shall be considered for contract award, subject to meeting each of the following conditions.
 - i) The Tenderer shall demonstrate that it has access to, or has available, liquid assets, unencumbered real assets, lines of credit, and other financial means (independent of any contractual advance payment) sufficient to meet the _____ construction cash flow of Kenya Shillings _____.
 - ii) Minimum average annual construction turnover of Kenya Shillings _____ *[insert amount]*, equivalent calculated as total certified payments received for contracts in progress and/or completed within the last _____ *[insert of year]* years.
 - iii) At least _____ *(insert number)* of contract(s) of a similar nature executed within Kenya, or the East African Community or abroad, that have been satisfactorily and substantially completed as a prime contractor, or joint venture member or sub-contractor each of minimum value Kenya shillings _____ equivalent.
 - iv) Contractor's Representative and Key Experts which are specified as _____

 - v) Contractors key equipment listed on the table "Contractor's Equipment" below and more specifically listed as *[specify requirements for each lot as applicable]* _____

 - iv) Other conditions depending on their seriousness.
 - a) **History of non-performing contracts:**

Tenderer and each member of JV in case the Tenderer is a JV, shall demonstrate that Non-performance of a contract did not occur because of the default of the Tenderer, or the member of a JV in the last _____ *(specify years)*. The required information shall be furnished in the appropriate form.
 - b) **Pending Litigation**

Financial position and prospective long-term profitability of the Single Tenderer, and in the case the Tenderer is a JV, of each member of the JV, shall remain sound according to criteria established with respect to Financial Capability under Paragraph (i) above if all pending litigation will be resolved against the Tenderer. Tenderer shall provide information on pending litigations in the appropriate form.
 - c) **Litigation History**

There shall be no consistent history of court/arbitral award decisions against the Tenderer, in the last _____ *(specify years)*. All parties to the contract shall furnish the information in the appropriate form about any litigation or arbitration resulting from contracts completed or ongoing under its execution over the years specified. A consistent history of awards against the Tenderer or any member of a JV may result in rejection of the tender.

QUALIFICATION FORMS SUMMARY

1 Item No.	2 Qualification Subject	3 Qualification Requirement	4 Document To be Completed by Tenderer	5 For Procuring Entity's Use (Qualification met or Not Met)
1	Nationality	Nationality in accordance with ITT 3.6	Forms ELI – 1.1 and 1.2, with attachments	
2	Conflict of Interest	No conflicts of interest in accordance with ITT 3.2	Form of Tender	
3	PPRA Eligibility	Not having been declared ineligible by the PPRA as described in ITT 3.7	Form of Tender	
4	State- owned Enterprise	Meets conditions of ITT 3.8	Forms ELI – 1.1 and 1.2, with attachments	
5	Goods, equipment and services to be supplied under the contract	To have their origin in any country that is not determined ineligible under ITT 4.1	Forms ELI – 1.1 and 1.2, with attachments	
6	History of Non-Performing Contracts	Non-performance of a contract did not occur as a result of contractor default since 1 st January [.....].	Form CON-2	
7	Not debarred Based on Execution of Tender/Proposal Securing Declaration by the Procuring Entity	Not debarred based on-execution of a Tender/Proposal Securing Declaration pursuant to ITT 19.9	Form of Tender	
8	Pending Litigation	Tender's financial position and prospective long-term profitability still sound according to criteria established in 3.1 and assuming that all pending litigation will NOT be resolved against the Tenderer.	Form CON – 2	
9	Litigation History	No consistent history of court/arbitral award decisions against the Tenderer since 1st January 2020	Form CON – 2	
10	Financial Capabilities	<p>(i) The Tenderer shall demonstrate that it has access to, or has available, liquid assets, unencumbered real assets, lines of credit, and other financial means (independent of any contractual advance payment) sufficient to meet the construction cash flow requirements estimated as Kenya Shillings <i>[insert amount]</i> equivalent for the subject contract(s) net of the Tenderer's other commitments.</p> <p>(ii) The Tenderers shall also demonstrate, to the satisfaction of the Procuring Entity, that it has adequate sources of finance to meet the cash flow requirements on works currently in progress and for future contract commitments.</p> <p>(iii) The audited balance sheets or, if not required by the laws of the Tenderer's country, other financial statements acceptable to the Procuring Entity, for the last Three (3)</p>	Form FIN – 3.1, with attachments	

1	2	3	4	5
Item No.	Qualification Subject	Qualification Requirement	Document To be Completed by Tenderer	For Procuring Entity's Use (Qualification met or Not Met)
		<i>Years</i> shall be submitted and must demonstrate the current soundness of the Tenderer's financial position and indicate its prospective long-term profitability.		
11	Average Annual Construction Turnover	Minimum average annual construction turnover of Kenya Shillings Ksh 200,000,000.00 , equivalent calculated as total certified payments received for contracts in progress and/or completed within the last one (1) year , divided by one (1) year .	Form FIN – 3.2	
12	General Construction Experience	Experience under construction contracts in the role of prime contractor, JV member, sub-contractor, or management contractor for at least the last one (1) year , starting 1 st January 2023	4. Form EXP – 4.1 Experience	
13	Specific Construction & Contract Management Experience	<p>A minimum number of two (2 No.) similar contracts specified below that have been satisfactorily and substantially completed as a prime contractor, joint venture member, management contractor or sub-contractor between 1st January 2018 and tender submission deadline i.e. 6th February 2024 (number) contracts, each of minimum value Kenya shillings 200,000,000.00, equivalent.</p> <p><i>[In case the Works are to be tender as individual contracts under multiple contract procedure, the minimum number of contracts required for purposes of evaluating qualification shall be selected from the options mentioned in ITT 35.4]</i></p> <p>The similarity of the contracts shall be based on the following: <i>[Based on Section VII, Scope of Works, specify the minimum key requirements in terms of physical size, complexity, construction method, technology and/or other characteristics including part of the requirements that may be met by specialized subcontractors, if permitted in accordance with ITT 34.3]</i></p>	Form EXP 4.2(a)	



SECTION IV – TENDERING FORMS

QUALIFICATION FORMS

1. FOREIGN TENDERERS 40%RULE

Pursuant to ITT 3.10, a foreign tenderer must complete this form to demonstrate that the tender fulfils this condition.

ITEM	Description of Work Item	Describe location of Source	COST in K. shillings	Comments, if any
A	Local Labor			
1				
2				
3				
4				
5				
B	Sub contracts from Local sources			
1				
2				
3				
4				
5				
C	Local materials			
1				
2				
3				
4				
5				
D	Use of Local Plant and Equipment			
1				
2				
3				
4				
5				
E	Add any other items			
1				
2				
3				
4				
5				
6				
	TOTAL COST LOCAL CONTENT			
	PERCENTAGE OF CONTRACT PRICE			

3.	Title of position: [_____]	
	Name of candidate:	
	Duration of appointment:	[insert the whole period (start and end dates) for which this position will be engaged]
	Time commitment: for this position:	[insert the number of days/week/months/ that has been scheduled for this position]
	Expected time schedule for this position:	[insert the expected time schedule for this position (e.g. attach high level Gantt chart)]
4.	Title of position: [_____]	
	Name of candidate:	
	Duration of appointment:	[insert the whole period (start and end dates) for which this position will be engaged]
	Time commitment: for this position:	[insert the number of days/week/months/ that has been scheduled for this position]
	Expected time schedule for this position:	[insert the expected time schedule for this position (e.g. attach high level Gantt chart)]
5.	Title of position: [insert title]	
	Name of candidate:	
	Duration of appointment:	[insert the whole period (start and end dates) for which this position will be engaged]
	Time commitment: for this position:	[insert the number of days/week/months/ that has been scheduled for this position]
	Expected time schedule for this position:	[insert the expected time schedule for this position (e.g. attach high level Gantt chart)]

4. FORM PER-2:

Resume and Declaration - Contractor's Representative and Key Personnel

Name of Tenderer

Position [#1]: [title of position from Form PER-1]		
Personnel information	Name:	Date of birth:
	Address:	E-mail:
	Professional qualifications:	
	Academic qualifications:	
	Language proficiency: [language and levels of speaking, reading and writing skills]	
Details	Address of Procuring Entity:	
	Telephone:	Contact (manager / personnel officer):
	Fax:	
	Job title:	Years with present Procuring Entity:

Summarize professional experience in reverse chronological order. Indicate particular technical and managerial

experience relevant to the project.

Project	Role	Duration of involvement	Relevant experience
<i>[main project details]</i>	<i>[role and responsibilities on the project]</i>	<i>[time in role]</i>	<i>[describe the experience relevant to this position]</i>

Declaration

I, the undersigned *[insert either "Contractor's Representative" or "Key Personnel" as applicable]*, certify that to the Lowest of my knowledge and belief, the information contained in this Form PER-2 correctly describes myself, my qualifications and my experience.

I confirm that I am available as certified in the following table and throughout the expected time schedule for this position as provided in the Tender:

Commitment	Details
Commitment to duration of contract:	<i>[insert period (start and end dates) for which this Contractor's Representative or Key Personnel is available to work on this contract]</i>
Time commitment:	<i>[insert period (start and end dates) for which this Contractor's Representative or Key Personnel is available to work on this contract]</i>

I understand that any misrepresentation or omission in this Form may:

- a) be taken into consideration during Tender evaluation;
- b) result in my disqualification from participating in the Tender;
- c) result in my dismissal from the contract.

Name of Contractor's Representative or Key Personnel: *[insert name]*

Signature: _____

Date: (day month year): _____

Countersignature of authorized representative of the Tenderer:

Signature: _____

Date: (day month year): _____

5. TENDERERS QUALIFICATION WITHOUT PREQUALIFICATION

To establish its qualifications to perform the contract in accordance with Section III, Evaluation and Qualification Criteria the Tenderer shall provide the information requested in the corresponding Information Sheets included hereunder.

FORM ELI-1.1

Tenderer Information Form

Date: _____

ITT No. and title: _____

Tenderer's name
In case of Joint Venture (JV), name of each member:
Tenderer's actual or intended country of registration: <i>[indicate country of Constitution]</i>
Tenderer's actual or intended year of incorporation:
Tenderer's legal address [in country of registration]:
Tenderer's authorized representative information Name: _____ Address: _____ Telephone/Fax numbers: _____ E-mail address: _____
1. Attached are copies of original documents of <input type="checkbox"/> Articles of Incorporation (or equivalent documents of constitution or association), and/or documents of registration of the legal entity named above, in accordance with ITT 4.4 <input type="checkbox"/> In case of JV, letter of intent to form JV or JV agreement, in accordance with ITT 4.1 <input type="checkbox"/> In case of state-owned enterprise or institution, in accordance with ITT 4.6, documents establishing: <ul style="list-style-type: none"> ● Legal and financial autonomy ● Operation under commercial law ● Establishing that the Tenderer is not under the supervision of the Procuring Entity
2. Included are the organizational chart and a list of Board of Directors.

FORM ELI - 1.2

Tenderer's JV Information Form
(to be completed for each member of Tenderer's JV)

Date: _____

ITT No. and title: _____

Tenderer's JV name:
JV member's name:
JV member's country of registration:
JV member's year of constitution:
JV member's legal address in country of constitution:
JV member's authorized representative information Name: _____ Address: _____ Telephone/Fax numbers: _____ E-mail address: _____
1. Attached are copies of original documents of <input type="checkbox"/> Articles of Incorporation (or equivalent documents of constitution or association), and/or registration documents of the legal entity named above, in accordance with ITT 4.4. <input type="checkbox"/> In case of a state-owned enterprise or institution, documents establishing legal and financial autonomy, operation in accordance with commercial law, and that they are not under the supervision of the Procuring Entity, in accordance with ITT 4.6. 2. Included are the organizational chart and a list of Board of Directors.

5.3 FORM CON -2

Historical Contract Non-Performance, Pending Litigation and Litigation History

Tenderer's Name: _____

Date: _____

JV Member's Name _____

ITT No. and title: _____

Non-Performed Contracts in accordance with Section III, Evaluation and Qualification Criteria			
<input type="checkbox"/> Contract non-performance did not occur since 1 st January <i>[insert year]</i> specified in Section III, Evaluation and Qualification Criteria, Sub-Factor 2.1.			
<input type="checkbox"/> Contract(s) not performed since 1 st January <i>[insert year]</i> specified in Section III, Evaluation and Qualification Criteria, requirement 2.1			
Year	Non-performed portion of contract	Contract Identification	Total Contract Amount (current value, currency, exchange rate and Kenya Shilling equivalent)
<i>[insert year]</i>	<i>[insert amount and percentage]</i>	Contract Identification: <i>[indicate complete contract name/ number, and any other identification]</i> Name of Procuring Entity: <i>[insert full name]</i> Address of Procuring Entity: <i>[insert City/ street/building/floor number/room number/country]</i> Reason(s) for non-performance: <i>[indicate main reason(s)]</i>	<i>[insert amount]</i>
Pending Litigation, in accordance with Section III, Evaluation and Qualification Criteria			
<input type="checkbox"/> No pending litigation in accordance with Section III, Evaluation and Qualification Criteria, Sub-Factor 2.3.			
<input type="checkbox"/> Pending litigation in accordance with Section III, Evaluation and Qualification Criteria, Sub-Factor 2.3 as indicated below.			

Year of dispute	Amount in dispute (currency)	Contract Identification	Total Contract Amount (currency), Kenya Shilling Equivalent (exchange rate)
		Contract Identification: _____ Name of Procuring Entity: _____ Address of Procuring Entity: _____ Matter in dispute: _____ Party who initiated the dispute: _____ Status of dispute: _____	
		Contract Identification: _____ Name of Procuring Entity: _____ Address of Procuring Entity: _____ Matter in dispute: _____ Party who initiated the dispute: _____ Status of dispute: _____	
Litigation History in accordance with Section III, Evaluation and Qualification Criteria			
<input type="checkbox"/> No Litigation History in accordance with Section III, Evaluation and Qualification Criteria, Sub-Factor 2.4.			
<input type="checkbox"/> Litigation History in accordance with Section III, Evaluation and Qualification Criteria, Sub-Factor 2.4 as indicated below.			
Year of	Outcome as	Contract Identification	Total Contract

award	percentage of Net Worth		Amount (currency), Kenya Shilling Equivalent (exchange rate)
[insert year]	[insert percentage]	Contract Identification: [indicate complete contract name, number, and any other identification] Name of Procuring Entity: [insert full name] Address of Procuring Entity: [insert City/street/building/floor number/room number/country] Matter in dispute: [indicate main issues in dispute] Party who initiated the dispute: [indicate "Procuring Entity" or "Contractor"] Reason(s) for Litigation and award decision [indicate main reason(s)]	[insert amount]

5.4 FORM FIN – 3.1:

Financial Situation and Performance

Tenderer's Name: _____
 Date: _____
 JV Member's Name _____
 ITT No. and title: _____

5.4.1. Financial Data

Type of Financial information in _____ (currency)	Historic information for previous _____ years, (amount in currency, currency, exchange rate*, KES equivalent)				
	Year 1	Year 2	Year 3	Year 4	Year 5
Statement of Financial Position (Information from Balance Sheet)					
Total Assets (TA)					
Total Liabilities (TL)					
Total Equity/Net Worth (NW)					
Current Assets (CA)					
Current Liabilities (CL)					
Working Capital (WC)					
Information from Income Statement					
Total Revenue (TR)					

Type of Financial information in _____ (currency)	Historic information for previous _____ years, (amount in currency, currency, exchange rate*, KES equivalent)				
Profits Before Taxes (PBT)					
Cash Flow Information					
Cash Flow from Operating Activities					

*Refer to ITT 15 for the exchange rate

5.4.2 Sources of Finance

Specify sources of finance to meet the cash flow requirements on works currently in progress and for future contract commitments.

No.	Source of finance	Amount (Kenya Shilling equivalent)
1		
2		
3		

5.4.3 Financial documents

The Tenderer and its parties shall provide copies of financial statements for _____ years pursuant Section III, Evaluation and Qualifications Criteria, Sub-factor 3.1. The financial statements shall:

- (a) reflect the financial situation of the Tenderer or in case of JV member, and not an affiliated entity (such as parent company or group member).
- (b) be independently audited or certified in accordance with local legislation.
- (c) be complete, including all notes to the financial statements.
- (d) correspond to accounting periods already completed and audited.

Attached are copies of financial statements¹ for the _____ years required above; and complying with the requirements

5.5 FORM FIN – 3.2:

Average Annual Construction Turnover

Tenderer's Name: _____

Date: _____

JV Member's Name _____

ITT No. and title: _____

¹ If the most recent set of financial statements is for a period earlier than 12 months from the date of Tender, the reason for this should be justified.

Annual turnover data (construction only)				
Year	Amount	Currency	Exchange rate	Kenya Shilling equivalent
<i>[indicate year]</i>	<i>[insert amount and indicate currency]</i>			
Average Annual Construction Turnover *				

* See Section III, Evaluation and Qualification Criteria, Sub-Factor 3.2.

5.6 **FORM FIN – 3.3:**

Financial Resources

Specify proposed sources of financing, such as liquid assets, unencumbered real assets, lines of credit, and other financial means, net of current commitments, available to meet the total construction cash flow demands of the subject contract or contracts as specified in Section III, Evaluation and Qualification Criteria

Financial Resources		
No.	Source of financing	Amount (Kenya Shilling equivalent)
1		
2		
3		

5.7 FORM FIN – 3.4:

Current Contract Commitments / Works in Progress

Tenderers and each member to a JV should provide information on their current commitments on all contracts that have been awarded, or for which a letter of intent or acceptance has been received, or for contracts approaching completion, but for which an unqualified, full completion certificate has yet to be issued.

Current Contract Commitments					
No.	Name of Contract	Procuring Entity's Contact Address, Tel,	Value of Outstanding Work [Current Kenya Shilling /month Equivalent]	Estimated Completion Date	Average Monthly Invoicing Over Last Six Months [Kenya Shilling /month]
1					
2					
3					
4					
5					

5.8 FORM EXP - 4.1

General Construction Experience

Tenderer's Name: _____

Date: _____

JV Member's Name _____

ITT No. and title: _____

Page _____ of _____ pages

Starting Year	Ending Year	Contract Identification	Role of Tenderer
		Contract name: _____ Brief Description of the Works performed by the Tenderer: _____ Amount of contract: _____ Name of Procuring Entity: _____ Address: _____	
		Contract name: _____ Brief Description of the Works performed by the Tenderer: _____ Amount of contract: _____ Name of Procuring Entity: _____ Address: _____	
		Contract name: _____ Brief Description of the Works performed by the Tenderer: _____ Amount of contract: _____ Name of Procuring Entity: _____ Address: _____	

5.9 FORM EXP -4.2(a)

Specific Construction and Contract Management Experience

Tenderer's Name: _____

Date: _____

JV Member's Name _____

ITT No. and title: _____

Similar Contract No.	Information			
Contract Identification				
Award date				
Completion date				
Role in Contract	Prime Contractor <input type="checkbox"/>	Member in JV <input type="checkbox"/>	Management Contractor <input type="checkbox"/>	Sub-contractor <input type="checkbox"/>
Total Contract Amount				Kenya Shilling
If member in a JV or sub-contractor, specify participation in total Contract amount				
Procuring Entity's Name:				
Address: Telephone/fax number E-mail:				

5.10 FORM EXP - 4.2 (a) (cont.)

Specific Construction and Contract Management Experience (cont.)

Similar Contract No.	Information
Description of the similarity in accordance with Sub-Factor 4.2(a) of Section III:	
1. Amount	
2. Physical size of required works items	
3. Complexity	
4. Methods/Technology	
5. Construction rate for key activities	
6. Other Characteristics	

5.11 FORM EXP - 4.2(b)

Construction Experience in Key Activities

Tenderer's Name: _____

Date: _____

Tenderer's JV Member Name: _____

Sub-contractor's Name² (as per ITT 34): _____

ITT No. and title: _____

All Sub-contractors for key activities must complete the information in this form as per ITT 34 and Section III, Evaluation and Qualification Criteria, Sub-Factor 4.2.

1. Key Activity No One: _

	Information			
Contract Identification				
Award date				
Completion date				
Role in Contract	Prime Contractor <input type="checkbox"/>	Member in JV <input type="checkbox"/>	Management Contractor <input type="checkbox"/>	Sub-contractor <input type="checkbox"/>
Total Contract Amount				Kenya Shilling
Quantity (Volume, number or rate of production, as applicable) performed under the contract per year or part of the year	Total quantity in the contract (i)	Percentage participation (ii)		Actual Quantity Performed (i) x (ii)
Year 1				
Year 2				
Year 3				

² If applicable

Information		
Year 4		
Procuring Entity's Name:		
Address: Telephone/fax number E-mail:		

Information	
Description of the key activities in accordance with Sub-Factor 4.2(b) of Section III:	

2. Activity No. Two
3.

OTHER FORMS

6. FORM OF TENDER

(Amended and issued pursuant to PPRA CIRCULAR No. 02/2022)

INSTRUCTIONS TO TENDERERS

- i) *All italicized text is to help the Tenderer in preparing this form.*
- ii) *The Tenderer must prepare this Form of Tender on stationery with its letterhead clearly showing the Tenderer's complete name and business address. Tenderers are reminded that this is a mandatory requirement.*
- iii) *Tenderer must complete and sign CERTIFICATE OF INDEPENDENT TENDER DETERMINATION and the SELF DECLARATION FORMS OF THE TENDERER as listed under (xxii) below.*

Date of this Tender submission:.....[insert date (as day, month and year) of Tender submission] **Tender**

Name and Identification:.....[insert identification] **Alternative**

No.:.....[insert identification No if this is a Tender for an alternative]

To: [Insert complete name of Procuring Entity]

Dear Sirs,

- In accordance with the Conditions of Contract, Specifications, Drawings for the execution of the above named Works, we, the undersigned offer to construct and complete the Works and remedy any defects therein for the sum of Kenya Shillings [[Amount in figures].....Kenya Shillings
[amount in words]_____

The above amount is broken down as per the Table below:

Breakdown of the Tender Price

Item	Description	Amount (in KES)	% to be paid in foreign currency	Foreign Currency
1	Preliminary items such as, insurance for works, notice boards, statutory payments i.e., OSHA, NCA, NEMA, Physical Planning, site office costs, etc. A maximum of 2% of the bid amount value			
2	Cost of designs A maximum of 6% of the bid amount value			
3	Project Management and Supervisory costs for consultants, (up to contract completion). A maximum of 4% of the bid amount value			
4	Monthly cost of major items of equipment (up to contract completion).			
5	Cost of Demolitions (a lumpsum figure)			
6	Cost of the works (a lumpsum figure).			

Item	Description	Amount (in KES)	% to be paid in foreign currency	Foreign Currency
	LOT 1			
	LOT 2			
	LOT 3			
	LOT 4			
	LOT 5			
	LOT 6	N/A (COVERED IN ITEM NO. 2)		
7	Any items specified in the TDS <i>(Describe them here)</i>			
8	Add Contingency of 10% of the Bid amount			
	TOTAL TENDER PRICE			

Amount in Words.....

.....

.....

.....

.....

The amount quoted above shall include provisional sums, and only allows not more than two foreign currencies.

2. We undertake, if our tender is accepted, to commence the Works as soon as is reasonably possible after the receipt of the Project Manager's notice to commence, and to complete the whole of the Works comprised in the Contract within the time stated in the Particular Conditions of Contract.
3. We agree to adhere by this tender until [Insert date], and it shall remain binding upon us and may be accepted at any time before that date.
4. Unless and until a formal Agreement is prepared and executed this tender together with your written acceptance thereof, shall constitute a binding Contract between us. We further understand that you are not bound to accept the lowest or any tender you may receive.
5. We, the under signed, further declare that:
 - (i) No reservations: We have examined and have no reservations to the tender document, including Addenda issued in accordance with ITT8;
 - (ii) Eligibility: We meet the eligibility requirements and have no conflict of interest in accordance with ITT 3 and 4;
 - (iii) Tender-Securing Declaration: We have not been debarred by the Authority based on execution of a Tender- Securing Declaration or Tender Securing Declaration in Kenya in accordance with ITT 19.8;
 - iv) Conformity: We offer to execute in conformity with the tendering documents and in accordance with the implementation and completion specified in the construction schedule, the following Works: *[insert a brief description of the Works]*;
 - (v) Tender Price: The total price of our Tender, excluding any discounts offered in item 1 above is: *[Insert one of the options below as appropriate]*
 - (vi) Discounts: The discounts offered and the methodology for their application are:
 - vii) The discounts offered are: *[Specify in detail each discount offered.]*
 - viii) The exact method of calculations to determine the net price after application of discounts is shown below: *[Specify in detail the method that shall be used to apply the discounts]*;
 - ix) Tender Validity Period: Our Tender shall be valid for the period specified in TDS 18.1 (as amended, if applicable) from the date fixed for the Tender submission deadline specified in TDS 22.1 (as amended, if applicable), and it shall remain binding upon us and may be accepted at any time before the expiration of that period;
 - x) Performance Security: If our Tender is accepted, we commit to obtain a Performance Security in accordance with the Tendering document;
 - xi) One Tender Per Tender: We are not submitting any other Tender (s) as an individual Tender, and we are not participating in any other Tender(s) as a Joint Venture member or as a subcontractor, and meet the requirements of ITT 3.4, other than alternative Tenders submitted in accordance with ITT 13.3;
 - xii) Suspension and Debarment: We, along with any of our subcontractors, suppliers, Project Manager, manufacturers, or service providers for any part of the contract, are not subject to, and not controlled by any entity or individual that is subject to, a temporary suspension or a debarment imposed by the Public Procurement Regulatory Authority or any other entity of the Government of Kenya, or any international organization.
 - xiii) State-owned enterprise or institution: *[select the appropriate option and delete the other] [We are not a state-owned enterprise or institution] / [We are a state-owned enterprise or institution but meet the requirements of ITT 3.8];*

- xiv) Commissions, gratuities, fees: We have paid, or will pay the following commissions, gratuities, or fees with respect to the tender process or execution of the Contract: *[insert complete name of each Recipient, its full address, the reason for which each commission or gratuity was paid and the amount and currency of each such commission or gratuity]*

Name of Recipient	Address	Reason	Amount

(If none has been paid or is to be paid, indicate “none.”)

- xv) Binding Contract: We understand that this Tender, together with your written acceptance thereof included in your Letter of Acceptance, shall constitute a binding contract between us, until a formal contract is prepared and executed;
- xvi) Not Bound to Accept: We understand that you are not bound to accept the lowest evaluated cost Tender, the Most Advantageous Tender or any other Tender that you may receive;
- xvii) Fraud and Corruption: We here by certify that we have taken steps to ensure that no person acting for us or on our behalf engages in any type of Fraud and Corruption;
- xviii) Collusive practices: We hereby certify and confirm that the tender is genuine, non-collusive and made with the intention of accepting the contract if awarded. To this effect we have signed the “Certificate of Independent Tender Determination” attached below.
- xix) **Code of Ethical Conduct**: We undertake to adhere by the Code of Ethical Conduct for Persons Participating in Public Procurement and Asset Disposal Activities in Kenya, copy available from www.pppra.go.ke during the procurement process and the execution of any resulting contract.
- xx) **Beneficial Ownership Information**: We commit to provide to the procuring entity the Beneficial Ownership Information in conformity with the Beneficial Ownership Disclosure Form upon receipt of notification of intention to enter into a contract in the event we are the successful tenderer in this subject procurement proceeding.
- xxi) We, the Tenderer, have duly completed, signed and stamped the following Forms as part of our Tender:
- Tenderer's Eligibility; Confidential Business Questionnaire—to establish we are not in any conflict to interest.
 - Certificate of Independent Tender Determination—to declare that we completed the tender without colluding with other tenderers.
 - Self-Declaration of the Tenderer - to declare that we will, if awarded a contract, not engage in any form of fraud and corruption.
 - declaration and commitment to the code of ethics for Persons Participating in Public Procurement and Asset Disposal Activities in Kenya,

Further, we confirm that we have read and understood the full content and scope of fraud and corruption as informed in

“**Appendix 1- Fraud and Corruption**” attached to the Form of Tender.

Name of the Tenderer: **[insert complete name of person signing the Tender]*

Name of the person duly authorized to sign the Tender on behalf of the Tenderer: ***[insert complete name of person duly authorized to sign the Tender]*

Title of the person signing the Tender: *[insert complete title of the person signing the Tender]*

Signature of the person named above: *[insert signature of person whose name and capacity are shown above]* **Date signed** *[insert date of signing] day of [insert month], [insert year]*

Date signed _____ day of _____, _____

Notes

** In the case of the Tender submitted by joint venture specify the name of the Joint Venture as Tenderer*

*** Person signing the Tender shall have the power of attorney given by the Tenderer to be attached with the Tender.*

TENDERER'S ELIGIBILITY- CONFIDENTIAL BUSINESS QUESTIONNAIRE

Instruction to Tenderer

Tender is instructed to complete the particulars required in this Form, *one form for each entity if Tender is a JV*. Tenderer is further reminded that it is an offence to give false information on this Form.

a) Tenderer's details

	ITEM	DESCRIPTION
1	Name of the Procuring Entity	
2	Reference Number of the Tender	
3	Date and Time of Tender Opening	
4	Name of the Tenderer	
5	Full Address and Contact Details of the Tenderer.	1. Country 2. City 3. Location 4. Building 5. Floor 6. Postal Address 7. Name and email of contact person.
6	Current Trade License Registration Number and Expiring date	
7	Name, country and full address (<i>postal and physical addresses, email, and telephone number</i>) of Registering Body/Agency	
8	Description of Nature of Business	
9	Maximum value of business which the Tenderer handles.	
10	State if Tenders Company is listed in stock exchange, give name and full address (<i>postal and physical addresses, email, and telephone number</i>) of state which stock exchange	

General and Specific Details

b) Sole Proprietor, provide the following details.

Name in full _____ Age _____

_____ Nationality

_____ Country of Origin

_____ Citizenship

c) **Partnership**, provide the following details.

	Names of Partners	Nationality	Citizenship	% Shares owned
1				
2				
3				

d) Registered Company, provide the following details.

i) Private or public Company _____

ii) State the nominal and issued capital of the Company:-

Nominal Kenya Shillings (Equivalent).....

Issued Kenya Shillings (Equivalent).....

iii) Give details of Directors as follows.

	Names of Director	Nationality	Citizenship	% Shares owned
1				
2				
3				

e) DISCLOSURE OF INTEREST- Interest of the Firm in the Procuring Entity.

i) Are there any person/persons in (Name of Procuring Entity) who has/have an interest or relationship in this firm? Yes/No.....

If yes, provide details as follows.

	Names of Person	Designation in the Procuring Entity	Interest or Relationship with Tenderer
1			
2			
3			

ii) Conflict of interest disclosure

	Type of Conflict	Disclosure YES OR NO	If YES provide details of the relationship with Tenderer
1	Tenderer is directly or indirectly controls, is controlled by or is under common control with another tenderer.		
2	Tenderer receives or has received any direct or indirect subsidy from another tenderer.		
3	Tenderer has the same legal representative as another tenderer		
4	Tender has a relationship with another tenderer, directly or through common third parties, that puts it in a position to influence the tender of another tenderer, or influence the decisions of the Procuring Entity regarding this tendering process.		
5	Any of the Tenderer's affiliates participated as a consultant in the preparation of the design or technical specifications of the works that are the subject of the tender.		
6	Tenderer would be providing goods, works, non-consulting services or		

	Type of Conflict	Disclosure YES OR NO	If YES provide details of the relationship with Tenderer
	consulting services during implementation of the contract specified in this Tender Document.		
7	Tenderer has a close business or family relationship with a professional staff of the Procuring Entity who are directly or indirectly involved in the preparation of the Tender document or specifications of the Contract, and/or the Tender evaluation process of such contract.		
8	Tenderer has a close business or family relationship with a professional staff of the Procuring Entity who would be involved in the implementation or supervision of the such Contract.		
9	Has the conflict stemming from such relationship stated in item 7 and 8 above been resolved in a manner acceptable to the Procuring Entity throughout the tendering process and execution of the Contract.		

f) Certification

On behalf of the Tenderer, I certify that the information given above is complete, current and accurate as at the date of submission.

Full Name

Title or Designation

(Signature)

(Date)

CERTIFICATE OF INDEPENDENT TENDER DETERMINATION

I, the undersigned, in submitting the accompanying Letter of Tender to the _____
_____ [Name of Procuring
Entity] for: _____ [Name and number
of tender] in response to the request for tenders made by: _____ [Name of
Tenderer] do here by make the following statements that I certify to be true and complete in every respect:

I certify, on behalf of _____ [Name of Tenderer]
that:

1. I have read and I understand the contents of this Certificate;
2. I understand that the Tender will be disqualified if this Certificate is found not to be true and complete in every respect;
3. I am the authorized representative of the Tenderer with authority to sign this Certificate, and to submit the Tender on behalf of the Tenderer;
4. For the purposes of this Certificate and the Tender, I understand that the word “competitor” shall include any individual or organization, other than the Tenderer, whether or not affiliated with the Tenderer, who:
 - a) Has been requested to submit a Tender in response to this request for tenders;
 - b) could potentially submit a tender in response to this request for tenders, based on their qualifications, abilities or experience;
5. The Tenderer discloses that [check one of the following, as applicable]:
 - a) The Tenderer has arrived at the Tender independently from, and without consultation, communication, agreement or arrangement with, any competitor;
 - b) the Tenderer has entered into consultations, communications, agreements or arrangements with one or more competitors regarding this request for tenders, and the Tenderer discloses, in the attached document(s), complete details thereof, including the names of the competitors and the nature of, and reasons for, such consultations, communications, agreements or arrangements;
6. In particular, without limiting the generality of paragraphs (5)(a) or (5)(b) above, there has been no consultation, communication, agreement or arrangement with any competitor regarding:
 - a) prices;
 - b) methods, factors or formulas used to calculate prices;
 - c) the intention or decision to submit, or not to submit, a tender; or
 - d) the submission of a tender which does not meet the specifications of the request for Tenders; except as specifically disclosed pursuant to paragraph(5)(b) above;
7. In addition, there has been no consultation, communication, agreement or arrangement with any competitor regarding the quality, quantity, specifications or delivery particulars of the works or services to which this request for tenders relates, except as specifically authorized by the procuring authority or as specifically disclosed pursuant to paragraph(5)(b) above;
8. the terms of the Tender have not been, and will not be, knowingly disclosed by the Tenderer, directly or indirectly, to any competitor, prior to the date and time of the official tender opening, or of the awarding of the Contract, whichever comes first, unless otherwise required by law or as specifically disclosed pursuant to paragraph (5)(b) above.

Name _____

Title _____

Date _____ [N

ame, title and signature of authorized agent of Tenderer and Date]

SELF-DECLARATION FORMS
FORM SD1

SELF DECLARATION THAT THE PERSON/ TENDERER IS NOT DEBARRED IN THE MATTER OF THE PUBLIC PROCUREMENT AND ASSET DISPOSAL ACT 2015.

I,, of Post Office Box being a resident of in the Republic of do hereby make a statement as follows: -

1. THAT I am the Company Secretary/ Chief Executive/ Managing Director/ Principal Officer/ Director of (*insert name of the Company*) who is a Bidder in respect of **Tender No.....** for..... (*insert tender title/ description*) for..... (*insert name of the Procuring entity*) and duly authorized and competent to make this statement.
2. THAT the aforesaid Bidder, its Directors and subcontractors have not been debarred from participating in procurement proceeding under Part IV of the Act.
3. THAT what is deponed to here in above is true to the best of my knowledge, information and belief.

.....
(Title)

.....
(Signature)

.....
(Date)

Bidder Official Stamp

FORM SD2

SELF DECLARATION THAT THE PERSON/TENDERER WILL NOT ENGAGE IN ANY CORRUPT OR FRAUDULENT PRACTICE.

I,of P. O. Box.....being a resident of..... in the Republic of..... do hereby make a statement as follows: -

1. THAT I am the Chief Executive/ Managing Director/ Principal Officer/ Director of.....
(insert name of the Company) who is a Bidder in respect of **Tender No.**.....for *(insert tender title/description)* for *(insert name of the Procuring entity)* and duly authorized and competent to make this statement.
2. THAT the aforesaid Bidder, its servants and/or agents /subcontractors will not engage in any corrupt or fraudulent practice and has not been requested to pay any inducement to any member of the Board, Management, Staff and/ or employees and/ or agents of..... *(insert name of the Procuring entity)* which is the procuring entity.
3. THAT the aforesaid Bidder, its servants and/or agents/subcontractors have not offered any inducement to any member of the Board, Management, Staff and/ or employees and/ or agents of..... *(name of the procuring entity)*.
4. THAT the aforesaid Bidder will not engage /has not engaged in any corrosive practice with other bidders participating in the subject tender.
5. THAT what is deponed to here in above is true to the best of my knowledge information and belief.

.....
(Title)

.....
(Signature)

.....
(Date)

Bidder's Official Stamp

DECLARATION AND COMMITMENT TO THE CODE OF ETHICS

I.....(person) on behalf of (*Name of the Business/ Company/ Firm*) declare that I have read and fully understood the contents of the Public Procurement& Asset Disposal Act, 2015, Regulations and the Code of Ethics for persons participating in Public Procurement and Asset Disposal activities in Kenya and my responsibilities under the Code.

I do hereby commit to abide by the provisions of the Code of Ethics for persons participating in Public Procurement and Asset Disposal.

Name of Authorized

signatory.....

Sign.....

.....

Position.....

Office address.....

Telephone..... E-

mail.....

...

Name of the Firm/Company.....

Date.....

(Company Seal/ Rubber Stamp where applicable)

Witness

Name.....

.....

Sign.....

Date.....

APPENDIX 1- FRAUD AND CORRUPTION

(Appendix 1 shall not be modified)

1. Purpose

The Government of Kenya's Anti-Corruption and Economic Crime laws and their sanction's policies and procedures, Public Procurement and Asset Disposal Act (*no. 33 of 2015*) and its Regulation, and any other Kenya's Acts or Regulations related to Fraud and Corruption, and similar offences, shall apply with respect to Public Procurement Processes and Contracts that are governed by the laws of Kenya.

2. Requirements

- 2.1 The Government of Kenya requires that all parties including Procuring Entities, Tenderers, (applicants/proposers), Consultants, Contractors and Suppliers; any Sub-contractors, Sub-consultants, Service providers or Suppliers; any Agents (whether declared or not); and any of their Personnel, involved and engaged in procurement under Kenya's Laws and Regulation, observe the highest standard of ethics during the procurement process, selection and contract execution of all contracts, and refrain from Fraud and Corruption and fully comply with Kenya's laws and Regulations as per paragraphs 1.1 above.
- 2.2 Kenya's public procurement and asset disposal act (*no. 33 of 2015*) under Section 66 describes rules to be followed and actions to be taken in dealing with Corrupt, Coercive, Obstructive, Collusive or Fraudulent practices, and Conflicts of Interest in procurement including consequences for offences committed. A few of the provisions noted below highlight Kenya's policy of no tolerance for such practices and behavior:
- 1) A person to whom this Act applies shall not be involved in any corrupt, coercive, obstructive, collusive or fraudulent practice; or conflicts of interest in any procurement or asset disposal proceeding;
 - 2) A person referred to under subsection (1) who contravenes the provisions of that sub-section commits an offence;
 - 3) Without limiting the generality of the subsection (1) and (2), the person shall be: -
 - a) disqualified from entering in to a contract for a procurement or asset disposal proceeding; or
 - b) if a contract has already been entered into with the person, the contract shall be voidable;
 - 4) The voiding of a contract by the procuring entity under sub section (7) does not limit any legal remedy the procuring entity may have;
 - 5) An employee or agent of the procuring entity or a member of the Board or committee of the procuring entity who has a conflict of interest with respect to a procurement: -
 - a) Shall not take part in the procurement proceedings;
 - b) Shall not, after a procurement contract has been entered in to, take part in any decision relating to the procurement or contract; and
 - c) Shall not be a subcontractor for the tenderer to whom was awarded contract, or a member of the group of tenderers to whom the contract was awarded, but the subcontractor appointed shall meet all the requirements of this Act.
 - 6) An employee, agent or member described in subsection (1) who refrains from doing anything prohibited under that subsection, but for that subsection, would have been within his or her duties shall disclose the conflict of interest to the procuring entity;
 - 7) If a person contravenes subsection (1) with respect to a conflict of interest described in subsection (5) (a) and the contract is awarded to the person or his relative or to another person in whom one of them had a direct or indirect pecuniary interest, the contract shall be terminated and all costs incurred by the public entity shall be made good by the awarding officer. Etc.
- 2.3 In compliance with Kenya's laws, regulations and policies mentioned above, the Procuring Entity:

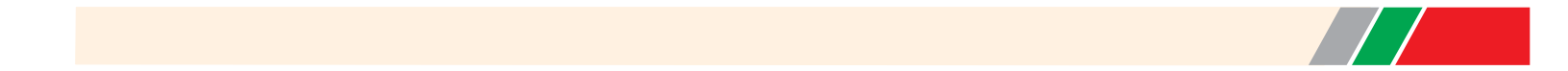

a) Defines broadly, for the purposes of the above provisions, the terms set forth below as follows:

- i) “corrupt practice” is the offering, giving, receiving, or soliciting, directly or indirectly, of anything of value to influence improperly the actions of another party;
 - ii) “fraudulent practice” is any act or omission, including misrepresentation, that knowingly or recklessly misleads, or attempts to mislead, a party to obtain financial or other benefit or to avoid an obligation;
 - iii) “collusive practice” is an arrangement between two or more parties designed to achieve an improper purpose, including to influence improperly the actions of another party;
 - iv) “coercive practice” is impairing or harming, or threatening to impair or harm, directly or indirectly, any party or the property of the party to influence improperly the actions of a party;
 - v) “obstructive practice” is:
 - Deliberately destroying, falsifying, altering, or concealing of evidence material to the investigation or making false statements to investigators in order to materially impede investigation by Public Procurement Regulatory Authority (PPRA) or any other appropriate authority appointed by Government of Kenya into allegations of a corrupt, fraudulent, coercive, or collusive practice; and/or threatening, harassing, or intimidating any party to prevent it from disclosing its knowledge of matters relevant to the investigation or from pursuing the investigation; or
 - Acts intended to materially impede the exercise of the PPRA's or the appointed authority's inspection and audit rights provided for under paragraph 2.3e. below.
- b) Defines more specifically, in accordance with the above procurement Act provisions set forth for fraudulent and collusive practices as follows:
- "fraudulent practice" includes a misrepresentation of fact in order to influence a procurement or disposal process or the exercise of a contract to the detriment of the procuring entity or the tenderer or the contractor, and includes collusive practices amongst tenderers prior to or after tender submission designed to establish tender prices at artificial non-competitive levels and to deprive the procuring entity of the benefits of free and open competition.
- c) Rejects a proposal for award of a contract if PPRA determines that the firm or individual recommended for award, any of its personnel, or its agents, or its sub-consultants, sub-contractors, service providers, suppliers and/ or their employees, has, directly or indirectly, engaged in corrupt, fraudulent, collusive, coercive, or obstructive practices in competing for the contract in question;
 - d) Pursuant to the Kenya's above stated Acts and Regulations, may sanction or debar or recommend to appropriate authority (ies) for sanctioning and debarment of a firm or individual, as applicable under the Acts and Regulations;
 - e) Requires that a clause be included in Tender documents and Request for Proposal documents requiring (i) Tenderers (applicants/proposers), Consultants, Contractors, and Suppliers, and their Sub-contractors, Sub-consultants, Service providers, Suppliers, Agents personnel, permit the PPRA or any other appropriate authority appointed by Government of Kenya to inspect all accounts, records and other documents relating to the procurement process, selection and/or contract execution, and to have them audited by auditors appointed by the PPRA or any other appropriate authority appointed by Government of Kenya; and
 - f) Pursuant to Section 62 of the above Act, requires Applicants/Tenderers to submit along with their Applications/Tenders/Proposals a “Self-Declaration Form” as included in the procurement document declaring that they and all parties involved in the procurement process and contract execution have not engaged/ will not engage in any corrupt or fraudulent practices.

1For the avoidance of doubt, a party's ineligibility to be awarded a contract shall include, without limitation, (i) applying for pre-qualification, expressing interest in A consultancy, and tendering, either directly or as a nominated sub-contractor, nominated consultant, nominated manufacturer or supplier, or nominated service provider, in respect of such contract, and (ii) entering into an addendum or amendment introducing a material modification to any existing contract.

2Inspections in this context usually are investigative (i.e., forensic) in nature. They involve fact-finding activities undertaken by the Investigating Authority or persons appointed by the Procuring Entity to address specific matters related to investigations/audits, such as evaluating the veracity of an allegation of possible Fraud and Corruption, through the appropriate mechanisms. Such activity includes but is not limited to: accessing and examining a firm's or individual's financial records and information, and making copies thereof as

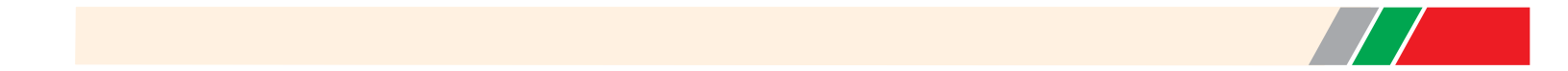

relevant; accessing and examining any other documents, data and information (whether in hard copy or electronic format) deemed relevant for the investigation/audit, and making copies there of as relevant; interviewing staff and other relevant individuals; performing physical inspections and site visits; and obtaining third party verification of information.

FORM OF TENDER SECURITY-[Option 1–Demand Bank Guarantee]

Beneficiary: _____

Request for Tenders No:

Date: _____

TENDER GUARANTEE No.: _____

Guarantor: _____

1. We have been informed that _____ (here inafter called "the Applicant") has submitted or will submit to the Beneficiary its Tender (here inafter called " the Tender") for the execution of _____ under Request for Tenders No. _____ ("the ITT").
2. Furthermore, we understand that, according to the Beneficiary's conditions, Tenders must be supported by a Tender guarantee.
3. At the request of the Applicant, we, as Guarantor, hereby irrevocably undertake to pay the Beneficiary any sum or sums not exceeding in total an amount of _____ (_____) upon receipt by us of the Beneficiary's complying demand, supported by the Beneficiary's statement, whether in the demand itself or a separate signed document accompanying or identifying the demand, stating that either the Applicant:
 - (a) has withdrawn its Tender during the period of Tender validity set forth in the Applicant's Letter of Tender ("the Tender Validity Period"), or any extension thereto provided by the Applicant; or
 - b) having been notified of the acceptance of its Tender by the Beneficiary during the Tender Validity Period or any extension there to provided by the Applicant, (i) has failed to execute the contract agreement, or (ii) has failed to furnish the Performance.
4. This guarantee will expire: (a) if the Applicant is the successful Tenderer, upon our receipt of copies of the contract agreement signed by the Applicant and the Performance Security and, or (b) if the Applicant is not the successful Tenderer, upon the earlier of (i) our receipt of a copy of the Beneficiary's notification to the Applicant of the results of the Tendering process; or (ii) thirty days after the end of the Tender Validity Period.
5. Consequently, any demand for payment under this guarantee must be received by us at the office indicated above on or before that date.

[signature(s)]

Note: All italicized text is for use in preparing this form and shall be deleted from the final product.

TENDER GUARANTEE No.: _____

1. Whereas [Name of the tenderer] (hereinafter called “the tenderer”) has submitted its tender dated [Date of submission of tender] for the [Name and/or description of the tender] (hereinafter called “the Tender”) for the execution of _____ under Request for Tenders No. _____ (“the ITT”).
2. KNOW ALL PEOPLE by these presents that WE of [Name of Insurance Company] having our registered office at (hereinafter called “the Guarantor”), are bound unto [Name of Procuring Entity] (hereinafter called “the Procuring Entity”) in the sum of (Currency and guarantee amount) for which payment well and truly to be made to the said Procuring Entity, the Guarantor binds itself, its successors and assigns, jointly and severally, firmly by these presents.

Sealed with the Common Seal of the said Guarantor this ___ day of _____ 20 __.

3. NOW, THEREFORE, THE CONDITION OF THIS OBLIGATION is such that if the Applicant:
 - a) has withdrawn its Tender during the period of Tender validity set forth in the Principal's Letter of Tender (“the Tender Validity Period”), or any extension thereto provided by the Principal; or
 - b) having been notified of the acceptance of its Tender by the Procuring Entity during the Tender Validity Period or any extension thereto provided by the Principal; (i) failed to execute the Contract agreement; or (ii) has failed to furnish the Performance Security, in accordance with the Instructions to tenderers (“ITT”) of the Procuring Entity's Tendering document.

then the guarantee undertakes to immediately pay to the Procuring Entity up to the above amount upon receipt of the Procuring Entity's first written demand, without the Procuring Entity having to substantiate its demand, provided that in its demand the Procuring Entity shall state that the demand arises from the occurrence of any of the above events, specifying which event(s) has occurred.

4. This guarantee will expire: (a) if the Applicant is the successful Tenderer, upon our receipt of copies of the contract agreement signed by the Applicant and the Performance Security and, or (b) if the Applicant is not the successful Tenderer, upon the earlier of (i) our receipt of a copy of the Beneficiary's notification to the Applicant of the results of the Tendering process; or (ii) twenty-eight days after the end of the Tender Validity Period.
5. Consequently, any demand for payment under this guarantee must be received by us at the office indicated above on or before that date.

[Date]

[Signature of the Guarantor]

[Witness]

[Seal]

Note: All italicized text is for use in preparing this form and shall be deleted from the final product.

TENDER-SECURING DECLARATION FORM {r 46 and 155(2)}

[The Bidder shall complete this Form in accordance with the instructions indicated]

Date: *[insert date (as day, month and year) of Tender*

Submission] Tender No.: *[insert number of tendering*

process] To: *[insert complete name of Purchaser]*

I/We, the undersigned, declare that:

1. I/We understand that, according to your conditions, bids must be supported by a Tender-Securing Declaration.
2. I/We accept that I/we will automatically be suspended from being eligible for tendering in any contract with the Purchaser for the period of time of *[insert number of months or years]* starting on *[insert date]*, if we are in breach of our obligation (s) under the bid conditions, because we– (a) have withdrawn our tender during the period of tender validity specified by us in the Tendering Data Sheet; or (b) having been notified of the acceptance of our Bid by the Purchaser during the period of bid validity, (i) fail or refuse to execute the Contract, if required, or (ii) fail or refuse to furnish the Performance Security, in accordance with the instructions to tenders.
3. I/We understand that this Tender Securing Declaration shall expire if we are not the successful Tenderer (s), upon the earlier of:
 - a) Our receipt of a copy of your notification of the name of the successful Tenderer; or
 - b) Thirty days after the expiration of our Tender.
4. I/We understand that if I am/we are/in a Joint Venture, the Tender Securing Declaration must be in the name of the Joint Venture that submits the bid, and the Joint Venture has not been legally constituted at the time of bidding, the Tender Securing Declaration shall be in the name so fall future partners as named in the letter of intent.

Signed:.....

Capacity / title (director or partner or sole proprietor, etc.)

.....

Name:..... Duly authorized to sign

the bid for and on behalf of: *[insert complete name of Tenderer]* Dated on..... day

of..... *[Insert date of signing]*

Seal or stamp

APPENDIX TO TENDER

Schedule of Currency requirements

Summary of currencies of the Tender for _____ *[insert name of Section of the Works]*.

<i>Name of currency</i>	<i>Amounts payable</i>
Local currency: _____	
Foreign currency #1: _____	
Foreign currency #2: _____	
Foreign currency #3: _____	
Provisional sums expressed in local currency	[To be entered by the Procuring Entity]



**PART II – PROCURING ENTITY'S
INFRASTRUCTURAL FACILITY
REQUIREMENTS**

SECTION VII - PROCURING ENTITY'S REQUIREMENTS

1.0 Background

The Government of Kenya (GoK) intends to establish a facility for the local production of human vaccines in order to strengthen the efforts of prevention of immunisable diseases, including COVID-19. This endeavor is of strategic importance to the national health and attainment of universal health coverage, a key goal in medium term III plan of 'Kenya Vision 2030' and the 'Big Four Agenda'. To achieve this objective, the GoK working through the Kenya BioVax Institute, desires to engage a Firm to design, build, operationalize and maintain the human vaccines manufacturing facility in Kenya.

1.1 Scope of the work

The KBI wishes to set up a product-agnostic, medium-sized, turn-key, 'Fill/Finish' facility in the initial instant, with the capability to produce up to 6.0 million doses of vaccines per month or month or 72 million doses per annum. This is to be established in a warehouse facility that has adequate spacing and room for installing sterile area facilities and utilities. Drug substance manufacturing ('Formulation') could then be considered at a later stage.

The project is to be actualized in two phases with Phase one being Enabling Works and Phase two being Equipment Installations.

The enabling works for the manufacturing facility shall include support installations and related civil works in readiness for installations of the manufacturing equipment. These works include but not limited to provision of Bio-waste management, clean water systems, effluent management, stable power provision, secure facility, concept designs of fill/finish and other related builder and civil works.

The design shall be for a bespoke, turn-key, human vaccines manufacturing facility incorporating novel technologies alongside training programs and operational support services and training.

Priority vaccines: COVID-19 (single dose, viral vector-based), Pneumococcal conjugate and DTP- HepB-HiB pentavalent. These are to be followed by HPV and Rotavirus.

Phase:	Key elements of scope required:
Phase 1a – Enabling Works	<ol style="list-style-type: none"> 1. Concept & Detailed Design of vaccine filling lines and related equipment; 2. Concept & Detailed Design of Enabling works within the proposed site 3. Enabling works and utilities installations <ol style="list-style-type: none"> a) Design Supply & Installation of Vaccine Bio-Waste Kill System; b) Design Supply & Installation of Effluent Treatment Plant (ETP); c) Drilling & Equipping Borehole; d) Design Supply & Installation of Water Treatment Plant; e) Associated Builders and Civil Works; f) Concept & detail Design of Fill & Finish Vaccine line;
Phase 1b – Equipment Installations & Validation	<ol style="list-style-type: none"> 1. <i>Design Reviews</i> 2. <i>Process equipment set-up</i> 3. <i>Plant Validation</i> 4. <i>Workforce training and development programs</i> 5. <i>Management systems set-up</i>

1.1 ENABLING WORKS (PHASE 1a)

1.2 LOT 1 - SUPPLY & INSTALLATION OF VACCINE BIO-WASTE KILL SYSTEM

The kill system shall be a fully automatic system to deactivate cell culture bio-waste collected from reactors, tanks, sinks and condensate. This waste is to be “killed” using thermal means and then cooled prior to dumping to the effluent treatment plant. The entire system had to be compact enough to fit within the manufacturing facility.

The system shall meet containment requirements of BSL1, 2 & 3 and other WHO requirements.

While quoting for Lot 1 works, bidders should allow in their quotes, factory tests visits and validation by independent GMP experts. **Further, bidders shall be required to issue technical specifications and data while returning the bids.**

The flow diagram below shows the concept of the proposed Bio-kill system:

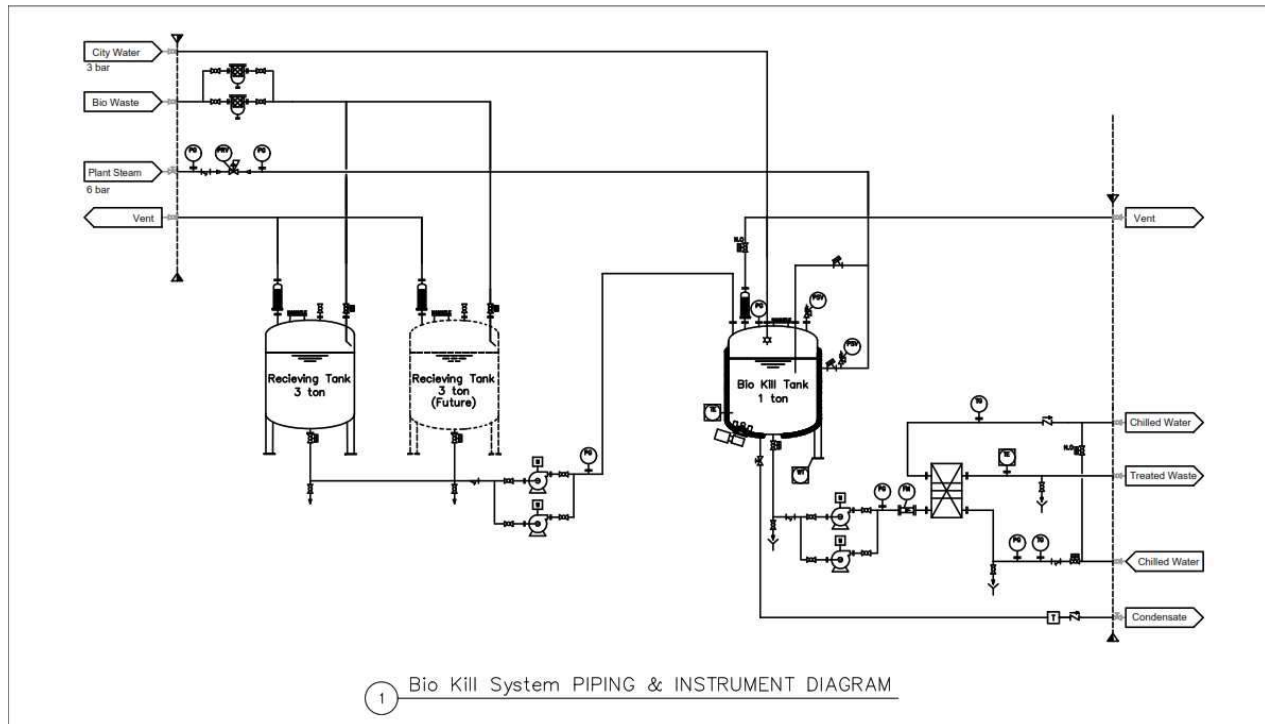

1.3 LOT 2 - SUPPLY & INSTALLATION OF EFFLUENT TREATMENT PLANT (ETP)

1.3.1 Detail Of Work & Specifications:

This lot contains scope of civil work and technical specifications for the bidder with respect to Civil works and equipment installation for the work of “Design, Supply, construction, Installation, and Commissioning of Sewage/Effluent treatment plant based on moving bed biological reactor technology (MBBR) of at least **20 m³/Day** capacity complete in all respects.

The tender is for turnkey job and the responsibility of the contractor will include all preparatory work, levelling and dressing of site, detailed design (hydraulic & structural), procurement, excavation work including de-watering and lowering of sub-soil water if required, disposal of all surplus earth at suitable site, civil works, testing and commissioning of ETP and operation & maintenance during trial run /defect liability period for 90 days and operation & maintenance for twelve (12) months.

1.3.2 Estimation of Effluent Flow

ETP will be designed for a flow of at least **20 m³/Day**.

1.3.3 Design & Drawings

The Site plan can be availed on request from the procuring entity. The bidder shall quote his/her rates based on the scope of work. However, this shall not absolve the bidder from responsibility of performance of the assets created in this contract. The bidders are required to furnish the following documents at the time of award of contact.

- a) Site Plan and Flow diagram / Plan layout/ civil structural drawing
- b) Hydraulic flow diagram

1.3.4 The Scope of work for successful bidder includes: -

- a) Submission of all documents required according to the contract parameters
- b) Submission of a guarantee that the treated effluent will correspond to the requirements given below;

1.3.5 Raw sewage & treated sewage characteristics:

For the design purpose for the proposed ETP the following parameters can to be adopted or the Bidder can take a sample at their own level

Characteristics of Influent Sewage

Parameters	Influent sewage Characteristics
pH	6-8.0
TSS mg/l	200
COD mg/l	450
BOD mg/l	550
TDS mg/l	2000
O&G mg/l	5

Characteristics of the effluent (from final out let of ETP)

Parameters	Effluent sewage Characteristics
pH	6-8.0
COD mg/l	≤ 100
BOD mg/l	≤ 200
TSS mg/l	≤ 50

1.4 LOT 3 – BOREHOLE DRILLING & EQUIPPING

1.4.1 Purpose

The borehole to be drilled, constructed, test pumped and equipped with a submersible pump under this contract will be to provide water intended for facility use. The maximum ground water abstraction permitted from the borehole shall be **10m³ /day** with the maximum abstraction period not exceeding **10 hours per day**.

The execution of the works shall be in full compliance with relevant provisions of the Water Act. The proposed drilling site will be AT PROCURING ENTITY PREMISES IN EMBAKASI. No claims will be allowed for the traveling or other expenses, which may be incurred by the Borehole Contractor's works.

1.4.2 Scope of the Work

The works included in the contract consist of two stages:-

STAGE 1:

Stage one comprises of:

A. Hydrological Study and Survey to confirm opportunity of borehole

Borehole contractor will be required to conduct a hydrological site survey using an established hydrologist to establish the best point to drill a borehole within the plot. A detailed report is to be given to the Services Engineer. The report should clearly indicate if it is viable to drill a borehole.

B. Formal Submittal to governing agencies

Borehole Contractor will have to make applications and acquire permits for drilling a bore hole from relevant authorities. This include WARMA and NEMA licenses and all other necessary documents as per the local authority requirements at the time of application. This will necessitate the activity of the next event.

Note: Stage 2 (Borehole drilling) shall take place if items A and B in stage 1 are successful

STAGE 2:

Stage two comprises of:

- a. The drilling of one borehole of sufficient diameter to provide for a finished cased and screened borehole of 200mm diameter to the provisional depth of about 350metres.

- b. The provision and installation of plain high density synthetic, slotted synthetic casings, and gravel pack, borehole cap, together with cementation works necessary.
- c. The supply and installation of 1No. Submersible borehole pump, complete with the necessary controls

Note: These depths and any other works can be varied by the Services Engineer depending on the actual conditions encountered in the process of executing of the works

1.4.3 Local Conditions

The borehole will be drilled, constructed and test pump in both unconsolidated and consolidated formation and the Borehole Contractor must be prepared to carry out the required work through any type of formation in the project area.

1.4.4 Borehole Data

- a. Total depth – 350m of 200mm diameter from surface (Provisional)
- b. Casings to be 200mm diameter and screened depth to be determined after borehole construction
- c. Static water level – not known
- d. Dynamic water level – not known
- e. Recommended pumping rate – 8-12m³/hr (for the purpose of quotation but to be confirmed after testing)
- f. (Pump) setting level – 320m (for the purpose of quotation but to be confirmed after testing)
- g. Total dynamic head to be determined on site

1.4.5 Casings

- a. Casings to be used as part of the permanent borehole structure shall be stainless steel suitable for borehole and having nominal diameter of 200mm.
- b. If any casing other than that to be left permanently in the borehole is required temporarily for execution of work, it shall be supplied by the Borehole Contractor free of charge.

1.4.6 Screens

The screens to be furnished and installed shall be of the pipe size variety having a minimum nominal diameter of 200mm and can be fabricated in three meter lengths. The screens shall be of continuous slot type and constructed entirely of stainless steel suitable for borehole installation. The screen shall have slot size opening of 1.4mm

1.4.7 Grouting

Grouting shall be done by either cement or bentonite to seal off unwanted upper aquifers under direction of the Services Engineer.

1.4.8 Construction Method

The borehole to be constructed shall be drilled by cable-tool percussion method or the

combination air/ hydraulic rotary method. The method of drilling shall be left to the discretion of the Borehole Contractor. After drilling to the final depth the Borehole Contractor shall proceed to insert permanent casings and screens as directed by the Services Engineer.

1.4.9 Gravel Pack

If filter gravel will be necessary, it will consist of durable, naturally rounded quartzitic particles properly washed and cleaned prior to insertion in the borehole. The gravel shall be introduced in the annular space between the wall of the borehole and the 200mm casing from the bottom to about 2 meters below surface. The final casing and screens must be centralized before gravel back and the Borehole Contractor must supply suitable equipment for lowering of gravel pack.

1.4.10 Cementation

The space above the gravel pack shall be grouted with a mix of one part of cement to two parts of sand and two parts of ballast, in order of 1:2:2 concrete may be used near the surface to form an annular plug around the casing of dimensions 1.0 x 1.0 x 1.0 meters. There shall be 2000mm diameter concrete plinth on top of the borehole and shall be constructed as shall be directed by the Services Engineer and the Structural Engineer.

Any other cementation works to be done as directed by the Services Engineer

1.4.11 Development

The Borehole Contractor shall furnish all necessary pumps, compressor, plungers, bailing or other needed equipment and shall develop the borehole by such approved methods as shall be necessary to give the maximum yield of water per increment of drawdown and extract from the formation of maximum practical quality of such sands as may, during the life of the borehole, be drawn through the screens when the borehole is operating under maximum conditions of draw down.

1.4.12 Test Pumping

After the borehole has been completed, constructed and developed, the Borehole Contractor shall make necessary arrangements for conducting a 24 hour continuous test pumping up to a maximum of 30hr and 12 hour recovery test under the supervision of the Services Engineer. Where the Services Engineer or his representative cannot be present on such pumping test, the Borehole Contractor may continue without him keeping accurate records of the test in terms of discharge and drawn down but must seek permission from the Services Engineer. Should the Borehole Contractor fail to keep such records, the Services Engineer shall order the test to be repeated at no extra cost.

1.4.13 Sample Formation

The Borehole Contractor shall keep an accurate record of the top and bottom of each stratum penetrated and shall save and deliver to the Services Engineer a sample of materials taken from each 2m of formation, or at every change of formation and at such other intervals as may be ordered by the Services Engineer. Those samples shall be placed in approved Borehole Contractor supplied containers with labels which indicate the depth at which the sample was obtained.

1.4.14 Water Samples

Water samples shall be collected at every water struck while drilling and also shall be collected at the start of every test and toward the end of the test in a three litre sterilized plastic container for both chemical and bacteriological analysis and submitted in a competent laboratory for analysis.

1.4.15 Reports

The Borehole Contractor shall submit to the Services Engineer daily progress reports showing:-

- a. The depth each day indicating drilling in meters per hour with comments on degree of hardness of materials being penetrated.
- b. Depth at which each water bearing zone is encountered and the rise and fall of water level in different formations.
- c. The full details of work carried out in respect of operations which are paid for at hourly rate
- d. The full details of the number of hours worked each day

1.4.16 Cessation of Work

The Services Engineer reserves the rights to stop drilling operations if in his opinion:

- a. A sufficient supply of water has been obtained
- b. The work is not being carried out in a satisfactory manner or
- c. Further drilling is unlikely to be advantageous or for any other reason.

In this event, payment shall be made only for the amount of work done up to the date of stoppage

1.4.17 Supply and Installation of Pump

The Borehole Contractor shall supply and install

- a. One electric submersible pump which will conform to the specification stated, for operation on 415 volt, 3-phase.
- b. All necessary electrical equipment for the pump such as control panel with starter, ammeter, single phasing cut-out, low voltage cut-out and all necessary cables for connection
- c. Suitable diameter Galvanized Steel pipe class 'C' to carry water to the surface/ to water storage tank

- d. Low level cut-out switch
- e. Airline 25mm upvc pipe for water level measurements
- f. Pressure gauge
- g. The gate valves, non-return valves before the master meter
- h. Master meter for measuring the water from the borehole

In addition the Borehole Contractor shall carry out 24 hours test run at the completion of the works. This test has to be certified by the Project Manager.

Note on Pump Installation

The Borehole Contractor shall install the borehole pump complete with all necessary accessories.

The Borehole Contractor shall make the necessary electrical connections and include in his prices all cable, starter-panel, switches etc. required to put the pump in operation while tendering for this part of the document and return it with full description literature and performance curves for the proposed equipment together with the tender for drilling works.

The installation of the submersible pump into the borehole shall be done immediately the borehole drilling is completed, test pumped and water analyzed for suitability for human consumption.

The final production pump to be installed in the newly drilled borehole shall be determined and installed as per the actual conditions encountered on completion of the drilling works. Hence the specifications given under the section of 'borehole data' are only for the purpose of quotation. After establishing the actual conditions of the drilled borehole, only the Services Engineer's approved submersible pump shall be installed.

1.4.18 Electrical works

It shall be the responsibility of the Borehole Contractor to provide all electrical wiring between all items of his Contract to ensure the correct function of his equipment. The Borehole Contractor's electrical works shall start from the nearest electrical isolator which is available within the site.

1.5 LOT 4 – SUPPLY & INSTALLATION OF WATER TREATMENT PLANT

1.5.1 Scope of Works

The envisioned scope of works of the water treatment plant shall include but not limited to the following;

- a. Water purification plant
- b. Transfer pumps of requisite adequate capacities
- c. Antiscalant dosing /PH correction of requisite capacity

- d. Reverse osmosis Units
- e. S.S water storage tank for Reverse Osmosis
- f. UV system of requisite adequate capacity
- g. Ozonator system with adequate capacity
- h. Recirculation Pumps
- i. Interconnection pipelines, control panels, Valves and Fillings
- j. Treated water storage tanks with adequate capacity

The fully integrated and automated water treatment plant including Reverse Osmosis unit shall be designed to produce an output of **40,000 litres** per day

1.5.2 Raw Water Analysis

Projected Raw water analysis results on nearing sites indicate high levels of PH, Colour, Turbidity, Iron, Sodium, Bicarbonates, Fluoride and TDS against desired limits as indicated in the table below.

Analytical parameter	Result	Set standards	Desired Limit	Units
PH	8.9	6.5-8.5	6.5-8.5	Mg/l
Iron	4.3	Max 0.3	Max 0.1	Mg/l
Sodium	111	Max 60	Max 100	Mg/l
Bi-carbonates	243	Max 91	Max 91	Mg/l
Fluoride	11.3	Max 1.5	Max 1.5	Mg/l
Total Dissolved Solids	295	Max 450	Max 200	Mg/l

The treated water shall be suitable for pharmaceutical facility consumption. The system of recovery should be properly designed corresponding to the raw water Total dissolved solid (TDS), Reverse Osmosis feed water limiting conditions as mentioned below are strictly maintained.

Parameter	Result
Turbidity	<1 NTU
Free Chloride	Nil
Oil & Grease	Nil
Iron	<0.1PPM
SDI	<4.0
Temperature	<45°C

1.5.3 Water Treatment Scheme

The integrated water treatment plant besides the Reverse Osmosis unit will comprise of the following component.

- **Water Source:** The source of the water is an onsite borehole located next to the plant site.
- **Buffer Storage:** The Tenderer to supply a raw water tank with a capacity of 40,000 Litres to be the feed tank for the plant.
- **Transfer pumps:** transfer pumps of suitable capacity and pressure rating for transfer feed water from raw water tank to balanced water tank to through the reverse Osmosis unit through the micron filters should be provided by the tenderer.
- **Antiscalants Dosing/PH Correction:** The on-line antiscalant/PH correction dosing of the feed water to prevent scaling of reverse Osmosis unit.
- **Antiscalants Dosing/PH Correction:** The on-line antiscalant/PH correction dosing of the feed water to prevent scaling of reverse Osmosis unit.
 - i. Pressure sand filter system
 - ii. Activated carbon filter system to meet the 40,000litres capacity
 - iii. Mineralization dosing system
 - iv. Water softener system shall be incorporated to carry out fine filtration before feeding the Reverse Osmosis unit membranes with the water
- **Reverse Osmosis Unit:** The Reverse Osmosis unit shall have a capacity of 4000litres per hour (Permeable) based on at-least 4-6 stages system, designed with local control panels based on automatic operation. The Reverse Osmosis Unit permeable water shall the conform to the following treated water analysis:
 - i. Total Dissolved Solid <50mg/L
 - ii. PH 6.0~6.5

1.5.4 Manuals, Drawings and Documentation

Operator's manuals shall be provided for all system equipment. The manuals shall include; interconnections, wiring, and control drawings accurately describing the equipment provided. The manual shall include;

- Operations and maintenance manuals
- Specifications catalogue

The Tenderer shall be obliged to submit the following drawings and documentation

- i. Piping and Instrumentation drawings, Equipment layout, general arrangement drawings and foundation drawing in advance through E-mail, CD or USB Drive.
- ii. Detailed specification of the equipment quoted by the vendor for supply and installation with full details of the manufacturer.
- iii. The shop floor drawings for all site fabricated items
- iv. Safety manuals of the plant

v. The complete list of important spare parts along with rates

1.5.5 Maintenance

The tenderers will be required to provide spares for maintenance of the plant for the first **one (1) year** at no additional charge. The tenderer will carry out all required preventive maintenance as per the recommendations of the manufacturer. This shall include; parts, Labour, any applicable tax and travel expenses at no extra cost. During this period, the Tenderer will train onsite technical personnel of the Procuring Entity so as to ensure smooth hand over of the equipment.

1.5.6 Erection and Commissioning

The vendor shall be responsible for providing the complete erection of integrated water treatment plant being supplied as per the order including:

- Plant Placement
- Installation of all accompanying systems
- Interconnection of the pipelines
- Connection of all utilities
- Drains whenever necessary complete in all respects for optimal performance

The vendor shall be responsible for Testing and Commissioning of the individual machines complete with the accompanying integrated lines. The tenderer shall as well carry out detailed lab tests of the resultant water from a recommended Kenya Government approved laboratory to ensure that the water complies to KEBs and WHO water safety standards. Such report will form part of completion certificate documentation.

1.5.7 Quality Of Material

All Plant, Equipment and materials supplied as part of the contract works shall be new and of first class commercial quality, shall be free from defects and imperfections and where indicated shall be of grades and classifications designated herein.

All products or materials not manufactured by the contractor shall be products of reputable manufactures and so far as the provisions of the specification is concerned shall be as if they had been manufactured by the contractor.

Materials and apparatus required for the complete installation as called for by the Specifications shall be supplied by the contractor or unless a specific mention is made otherwise.

Materials and apparatus supplied by others for installation and connection by the contractor or shall be carefully examined by the contractor on receipt and should any defects be noted; the contractor shall immediately notify the Engineer in writing.

Defective or damaged equipment at the point or during installation shall be replaced as required to the acceptable standard and an approval issued by the Engineer.

1.5.8 Regulation and Standards

The contractor works shall comply with the current editions of the following:

- i. The Kenya Government Regulations
- ii. The United Kingdom Chartered Institute of Buildings Services Engineers (CIBSE) Guidelines
- iii. British Standards and Codes of Practice as published by the British Standards Institutions (BSI).
- iv. The Local Council and /or Authority By-laws
- v. The Electricity Supply Authority By-laws
- vi. World Health Organization (WHO)
- vii. The Kenya Bureau of Standards (KEBS)

1.5.9 Power Supply on Site

The Procuring Entity will avail 415 volts, 3phase power supply on site for the contractor. The contractor will be responsible for all connection to the mains availed on site and take responsibility for the connection.

The contractor shall seek all necessary approvals from KPLC and all other bodies to allow for connection to the mains power availed on site by the Procuring Entity.

The contractor shall indemnify the Procuring Entity from any errors /destruction of property arising from an error in connection to the mains power line provided on site.

1.6 LOT 5 – DESIGN AND BUILD OF ASSOCIATED BUILDERS AND CIVIL WORKS

1.6.1 Scope of Works

a) Builders Works

Bidders will be required to submit design concepts of the site layout and related infrastructure.

- Driver Lounge
- Washrooms
- Lactation room
- Canteen
- Gate House
- Power House
- Pump rooms
- Parking Yard

1.6.2 Civil/ Structural Works

- i. Creating site boundaries;
- ii. Building Gate and Gate house / Site security systems and required accessories meeting BSL 2 Standards
- iii. Creating and Marking Parking yard
- iv. Building Electrical house and related Utility rooms e.g. generator house
- v. Provision of Raw water tank and Fire tank
- vi. Loading / Unloading platform for goods receipt (Dock-leveler)
- vii. Building a staff canteen
- viii. External Washrooms [gents + ladies + PWD] 35sqm

1.6.3 Electrical Works:

- i. Underground cable trenches / Overhead cable racks
- ii. Earth pit and Earthing connection panel
- iii. Lightning arrestor
- iv. Street / Pole Lights across the plot

1.6.4 Mechanical Works:

- i. Complete plumbing and drain piping work
- ii. Fire hydrant system and pump room including fire pump: Fire hydrant piping /pumps, fire hose with cabinet and hose reels as per local norms
- iii. **Galvanized** Pressed steel Water storage as per standards of capacity 48m³(4x4x3m) on a 10meters galvanized steel structural tower complete with foundation details and accessories. Plate thickness: 6mm

1.6.5 Supplementary Information

Set-up is assembly and installation of equipment, machineries and utilities starting at the assembly site at BioVax Institute facility in Embakasi Nairobi. Bidders are encouraged to visit the site and capture all relevant information.

1.7 LOT 6: CONCEPT AND DETAILED DESIGN FOR THE FILL AND FINISH VACCINE LINE

Fill/Finish' facility with the capability to produce up to 6.0 million doses of vaccines per month or 72 million doses per annum. This is to be established in a warehouse facility that has adequate spacing and room for installing sterile area facilities and utilities. Drug substance manufacturing ('Formulation') could then be considered at a later stage.

N: B (Only designs to be submitted)

ALL DESIGN PROPOSALS TO BE GREEN CONSCIOUS AND ENVIRONMENTALLY FRIENDLY

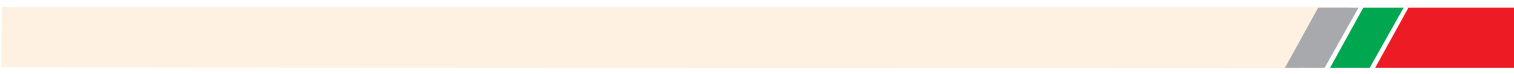

**PART III - THE CONDITIONS OF
CONTRACT AND CONTRACT
FORMS**

SECTION VIII - GENERAL CONDITIONS OF CONTRACT (GCC)

[Name of Procuring Entity]

[Name of Contract] [Project

Manager's Name and Address]

General Conditions of Contract

1. GENERAL PROVISIONS

1.1 Definitions-

In this Contract, except where context otherwise requires, the following terms shall be interpreted as indicated below. Words indicating persons or parties include corporations and other legal entities, except where the context requires otherwise.

“Accepted Contract Amount” means the amount accepted in the Letter of Acceptance for the execution and completion of the Works and the remedying of any defects.

“Bill of Quantities” means the priced and completed Bill of Quantities forming part of the tender. **“Completion Date”** means the date of completion of the Works as certified by the Project Manager.

“Contract” means the agreement entered into between the Procuring Entity and the Contractor as recorded in the Agreement Form and signed by the parties including all attachments and appendices thereto and all documents incorporated by reference therein to execute, complete, and maintain the Works.

“Contractor” means the person(s) named as contractor in the Form of Tender accepted by the Procuring Entity.

“Particular Conditions of Contract” means the pages completed by the Procuring Entity entitled Particular Conditions of Contract which constitute Part A of the Particular Conditions.

“Contractor's Documents” means the calculations, computer programs and other software, progress reports, drawings, manuals, models and other documents of a technical nature (if any) supplied by the Contractor under the Contract.

“Contractor's Equipment” means all apparatus, machinery, vehicles and other things required for the execution and completion of the Works and the remedying of any defects. However, Contractor's Equipment excludes Temporary Works, Procuring Entity's Equipment (if any), Plant, Materials and any other things intended to form or forming part of the Permanent Works.

“Contract Price” means the price defined in the contract and thereafter as adjusted in accordance with the provisions of the Contract.

“Contractor's Personnel” means the Contractor's Representative and all personnel whom the Contractor utilizes on Site, who may include the staff, labor and other employees of the Contractor and of each Subcontractor; and any other personnel assisting the Contractor in the execution of the Works.

“Contractor's Representative” means the person named by the Contractor in the Contractor appointed from time to time by the Contractor who acts on behalf of the Contractor.

“Cost” means expenditure reasonably incurred (or to be incurred) by the Contractor, whether on or off the Site, including overhead and similar charges, but does not include profit.

“Day” means a calendar day and **“year”** means 365 days.

“Day works” means Work inputs subject to payment on a time basis for labor and the associated materials and plant.

“Defects Notification Period” means the period for notifying defects in the Works or a Section (as the case may be) under Sub-Clause 11.1 [Completion of Outstanding Work and Remedying Defects], which extends over the days stated in the Particular Conditions of Contract.

“Defects Liability Period” means the period named in the Particular Conditions of Contract and calculated from the Completion Date, within which the contractor is liable for any defects that may develop in the handed over works.

“Defect” means any part of the Works not completed in accordance with the Contract.

“Defects Liability Certificate” means the certificate issued by Project Manager upon correction of defects by the Contractor.

“Drawings” means the drawings of the Works, as included in the Contract, and any additional and modified drawings issued by (or on behalf of) the Procuring Entity in accordance with the Contract.

“Procuring Entity” means the Procuring Entity named as Procuring Entity in the Particular Conditions of Contract.

“Procuring Entity's Personnel” means the Project Manager, the Project Manager, the assistants and all other staff, labor and other employees of the Project Manager and of the Procuring Entity; and any other personnel notified to the Contractor, by the Procuring Entity or the Project Manager, as Procuring Entity's Personnel.

“Procuring Entity's Equipment” means the apparatus, machinery and vehicles (if any) made available by the Procuring Entity for the use of the Contractor in the execution of the Works, as stated in the Specification; but does not include Plant which has not been taken over by the Procuring Entity.

“Project Manager” means the person appointed by the Procuring Entity to act as the Project Manager for the purposes of the Contract and named in the Particular Conditions of Contract, or other person appointed from time to time by the Procuring Entity and notified to the Contractor

“Final Payment Certificate” means the payment certificate issued under Sub-Clause 14.13 [Issue of Final Payment Certificate].

“Final Statement” means the statement defined in Sub-Clause 14.11 [Application for Final Payment Certificate]. **“Force Majeure”** is defined in Clause 19 [Force Majeure].

“Foreign Currency” means a currency of another country (not Kenya) in which part (or all) of the Contract Price is payable, but not the Local Currency.

“Goods” means Contractor's Equipment, Materials, Plant and Temporary Works, or any of them as appropriate.

“Interim Payment Certificate” means a payment certificate issued under Clause 14 [Contract Price and Payment], other than the Final Payment Certificate.

“Laws” means all national (or state) legislation, statutes, ordinances and other laws, and regulations and by-laws of any legally constituted public authority.

“Letter of Acceptance” means the letter of formal acceptance, signed by the Procuring Entity, including any annexed memoranda comprising agreements between and signed by both Parties.

“Local Currency” means the currency of Kenya.

“Materials” means things of all kinds (other than Plant) intended to form or forming part of the Permanent Works, including the supply-only materials (if any) to be supplied by the Contractor under the Contract.

“Notice of Dissatisfaction” means the notice given by either Party to the other under Sub-Clause 20.3 indicating its dissatisfaction and intention to commence arbitration.

“Party” means the Procuring Entity or the Contractor, as the context requires.

“Payment Certificate” means a payment certificate issued under Clause 14 [Contract Price and Payment].

“Performance Security” means the security (or securities, if any) under Sub-Clause 4.2 [Performance Security]. **“Performance Certificate”** means the certificate issued under Sub-Clause 11.9 [Performance Certificate]. **“Permanent Works”** means the permanent works to be executed by the Contractor under the Contract.

“Plant” means the apparatus, machinery and other equipment intended to form or forming part of the Permanent Works, including vehicles purchased for the Procuring Entity and relating to the construction or operation of the Works.

“Provisional Sum” means a sum (if any) which is specified in the Contract as a provisional sum, for the execution of any part of the Works or for the supply of Plant, Materials or services under Sub-Clause 13.5 [Provisional Sums].

“Project Manager” is the person named in the Appendix to Conditions of Contract (or any other competent person appointed by the Procuring Entity and notified to the Contractor, to act in replacement of the Project Manager) who is responsible for supervising the execution of the Works and administering the Contract and shall be an “Architect” or a “Quantity Surveyor” registered under the Architects and Quantity Surveyors Act Cap 525 or an “Project Manager” registered under Project Managers Registration Act Cap 530.

“Retention Money” means the accumulated retention moneys which the Procuring Entity retains under Sub-Clause 14.3 [Application for Interim Payment Certificates] and pays under Sub-Clause 14.9 [Payment of Retention Money].

“Schedules” means the document (s) entitled schedules, completed by the Contractor and submitted with the Form of Tender, as included in the Contract.

“Section” means a part of the Works specified in the Particular Conditions of Contract as a Section (if any)

“Site” means the places where the Permanent Works are to be executed, including storage and working areas, and to which Plant and Materials are to be delivered, and any other places as may be specified in the Contract as forming part of the Site.

“Site Investigation Reports” are those reports that may be included in the tendering documents which are factual and interpretative about the surface and subsurface conditions at the Site.

“Specification” means the document entitled specification, as included in the Contract, and any additions and modifications to the specification in accordance with the Contract. Such document specifies the Works.

“Statement” means a statement submitted by the Contractor as part of an application, under Clause 14 [Contract Price and Payment], for a payment certificate.

“Start Date” or “Commencement Date” is the latest date when the Contractor shall commence execution of the Works. It does not necessarily coincide with the Site possession date(s).

“Subcontractor” means any person named in the Contract as a subcontractor, or any person appointed as a subcontractor, for a part of the Works.

“Taking-Over Certificate” means a certificate issued under Clause 10 [Procuring Entity's Taking Over].

“Temporary Works” means all temporary works of every kind (other than Contractor's Equipment) required on Site for the execution and completion of the Permanent Works and the remedying of any defects.

“Tender” means the Form of Tender and all other documents which the Contractor submitted with the Form of Tender, as included in the Contract.

“Tests on Completion” means the tests which are specified in the Contractor agreed by both Parties or instructed as a Variation, and which are carried out under Clause 9 [Tests on Completion] before the Works or a Section (as the case maybe) are taken over by the Procuring Entity.

“Tests after Completion” means the tests (if any) which are specified in the Contract and which are carried out in accordance with the Specification after the Works or a Section (as the case may be) are taken over by the Procuring Entity.

“Time for Completion” means the time for completing the Works or a Section (as the case may be) as stated in the Particular Conditions of Contract (with any extension calculated from the Commencement Date.

“Temporary works” means works designed, constructed, installed, and removed by the Contractor which are needed for construction or installation of the Works.

“Unforeseeable” means not reasonably foreseeable by an experienced contractor by the Base Date.

“Variation” means any change to the Works, which is instructed or approved as a variation under Clause 13 [Variations and Adjustments].

“Works” means the items the Procuring Entity requires the Contractor to construct, install, and turnover to the Procuring Entity, as defined in the Appendix to Conditions of Contract. **“Works” may** also mean the Permanent Works and the Temporary Works, or either of them as appropriate.

1.2 Interpretation

In the Contract, except where the context requires otherwise:

- a) Words indicating one gender include all genders;
- b) words indicating the singular also include the plural and words indicating the plural also include the singular;
- c) provisions including the word “agree”, “agreed” or “agreement” require the agreement to be recorded in writing;
- d) “written” or “in writing” means hand-written, type-written, printed or electronically made, and resulting in a permanent record; and
- e) The marginal words and other headings shall not be taken in to consideration in the interpretation of these Conditions.

1.3 Communications

Wherever these Conditions provide for the giving or issuing of approvals, certificates, consents, determinations, notices, requests and discharges, these communications shall be:

- a) In writing and delivered by hand (against receipt), sent by mail or courier, or transmitted using any of the agreed systems of electronic transmission as stated in the Particular Conditions of Contract; and
- b) delivered, sent or transmitted to the address for the recipient's communications as stated in the Particular Conditions of Contract. However:
 - i) if the recipient gives notice of another address, communications shall thereafter be delivered accordingly; and
 - ii) if the recipient has not stated otherwise when requesting an approval or consent, it may be sent to the address from which the request was issued.

Approvals, certificates, consents and determinations shall not be unreasonably withheld or delayed. When a certificate is issued to a Party, the certifier shall send a copy to the other Party. When a notice is issued to a Party, by the other Party or the Project Manager, a copy shall be sent to the Project Manager or the other Party, as the case may be.

1.4 Law and Language

1.4.1 The Contract shall be governed by the laws of **Kenya**.

1.4.2 The ruling language of the Contract shall be **English**.

1.5 Priority of Documents

1.5.1 The documents forming the Contract are to be taken as mutually explanatory of one another. For the purposes of interpretation, the priority of the documents shall be in accordance with the following sequence:

- a) The Contract Agreement,
- b) The Letter of Acceptance,
- c) The Form of Tender,
- d) The Particular Conditions–Part A,
- e) The Particular Conditions–Part B
- f) These General Conditions of Contract
- g) The Specifications
- h) the Drawings, and
- i) the Schedules and any other documents forming part of the Contract.

If an ambiguity or discrepancy is found in the documents, the Project Manager shall issue any necessary clarification or instruction.

- 1.5.1 Prior to commencing construction works, the Contractor shall prepare and submit to the Procuring Entity for approval drawings and specifications (including Bills of Quantities, (if need be) which will guide on the contract works to be carried out The Specifications shall be prepared taking the following Notes for preparing Specifications.

Specifications

1. Specifications must be drafted to present a clear and precise statement of the required standards of materials, and workmanship to the requirements of the Procuring Entity. The Specifications should require that all materials, plant, and other supplies to be permanently incorporated in the Works be new, unused, of the most recent or current models, and incorporating all recent improvements in design and materials unless provided otherwise in the Contract.
2. Specifications from previous similar projects are useful and may not be necessary to re-write specifications for every Works Contract.
3. There are considerable advantages in standardizing **General Specifications** for repetitive Works in recognized public sectors, such as highways, urban housing, irrigation and water supply. The General Specifications should cover all classes of workmanship, materials and equipment commonly involved in constructions, although not necessarily to be used in a particular works contract. Deletions or addenda should then adapt the General Specifications to the particular Works.
4. Care must be taken in drafting Specifications to ensure they are not restrictive. In the Specifications of standards for materials, plant and workmanship, existing Kenya Standards should be used as much as possible, otherwise recognized international standards may also be used.
5. The Procuring Entity should decide whether technical solutions to specified parts of the Works are to be permitted. Alternatives are appropriate in cases where obvious (and potentially less costly) alternatives are possible to the technical solutions indicated in tender documents for certain elements of the Works, taking into consideration the comparative specialized advantage of potential tenderers.
6. The Contractor should provide a description of the selected parts of the Works with appropriate reference to Drawings, Specifications, Bills of Quantities, and Design or Performance criteria, stating that the alternative solutions shall be at least structurally and functionally equivalent to the basic design parameters and Specifications.
7. Such alternative solutions shall be accompanied by all information necessary for a complete evaluation by the Procuring Entity, including drawings, design calculations, technical specifications, breakdown of prices, proposed construction methodology, and other relevant details. Technical alternatives permitted in this manner shall be considered by the Procuring Entity each on its own merits and independently of whether the contractor has priced the item as described in his design included with the contract documents.

1.6 Contract Agreement

The Parties shall enter into a Contract Agreement within 28 days after the Contractor receives the Letter of Acceptance, unless the Particular Conditions establish otherwise. The Contract Agreement shall be based upon the form annexed to the Particular Conditions. The costs of stamp duties and similar charges (if any) imposed by law in connection with entry into the Contract Agreement shall be borne by the Procuring Entity.

1.7 Assignment

Neither Party shall assign the whole or any part of the Contractor any benefit or interest in or under the Contract. However, either Party:

- a) May assign the whole or any part with the prior agreement of the other Party, at the sole discretion of such other Party, and
- b) may, as security in favor of a bank or financial institution, assign its right to any moneys due, or to become due, under the Contract.

1.8 Care and Supply of Documents

1.8.1 The Specifications and Drawings shall be in the custody and care of the Procuring Entity. Unless otherwise stated in the Contract, two copies of the Contract and of each subsequent Drawings and Bills of Quantities shall be supplied to the Contractor, who may make or request further copies at the cost of the Contractor.

1.8.2 Each of the Contractor's Documents shall be in the custody and care of the Contractor, unless and until taken over by the Procuring Entity. Unless otherwise stated in the Contract, the Contractor shall supply to the Project Manager two copies of each of the Contractor's Documents.

1.8.3 The Contractor shall keep, on the Site, a copy of the Contract, publications named in the Specification, the Contractor's Documents (if any), the Drawings and Variations and other communications given under the Contract. The Procuring Entity's Personnel shall have the right to access to all these documents at all reasonable times.

1.8.4 If a Party become saw are of an error or defect in a document which was prepared for use in executing the Works, the Party shall promptly give notice to the other Party of such error or defect.

1.9 Delayed Instructions

1.9.1 The Contractor shall give notice to the Project Manager whenever the Works are likely to be delayed or disrupted if any necessary instruction is not issued to the Contractor within a particular time, which shall be reasonable. The notice shall include details of the necessary instruction, details of why and by when it should be issued, and the nature and amount of the delay or disruption likely to be suffered if it is late.

1.9.2 If the Contractor suffers delay and/or incurs Cost as a result of a failure of the Project Manager to issue the notified instruction within a time which is reasonable and is specified in the notice with supporting details, the Contractor shall give a further notice to the Project Manager and shall be entitled subject to Sub-Clause 20.1 [Contractor's Claims] to:

- a) an extension of time for any such delay, if completion is or will be delayed, under Sub-Clause 8.4 [Extension of Time for Completion], and
- b) payment of any such Cost-plus profit, which shall be included in the Contract Price.

1.9.3 After receiving this further notice, the Project Manager shall proceed in accordance with Sub-Clause 3.5 [Determinations] to agree or determine these matters.

1.9.4 However, if and to the extent that the Project Manager's failure was caused by any error or delay by the Contractor, including an error in, or delay in the submission of, any of the Contractor's Documents, the Contractor shall not be entitled to such extension of time, Cost or profit.

1.10 Procuring Entity's Use of Contractor's Documents

1.10.1 As between the Parties, the Contractor shall retain the copyright and other intellectual property rights in the Contractor's Documents and other design documents made by (or on behalf of) the Contractor.

- 1.10.2 The Contractor shall be deemed (by signing the Contract) to give to the Procuring Entity a non-terminable transferable non-exclusive royalty-free license to copy, use and communicate the Contractor's Documents, including making and using modifications of them. This license shall:
- a) apply throughout the actual or intended working life (whichever is longer) of the relevant parts of the Works,
 - b) entitle any person in proper possession of the relevant part of the Works to copy, use and communicate the Contractor's Documents for the purposes of completing, operating, maintaining, altering, adjusting, repairing and demolishing the Works, and
 - c) in the case of Contractor's Documents which are in the form of computer programs and other software, permit their use on any computer on the Site and other places as envisaged by the Contract, including replacements of any computers supplied by the Contractor.
- 1.10.3 The Contractor's Documents and other design documents made by (or on behalf of) the Contractor shall not, without the Contractor's consent, be used, copied or communicated to a third party by (or on behalf of) the Procuring Entity for purposes other than those permitted under Sub-Clause 1.10.2.

1.11. Contractor's Use of Procuring Entity's Documents

- 1.11.1 As between the Parties, the Procuring Entity shall retain the copyright and other intellectual property rights in the Specification, the Drawings and other documents made by (or on behalf of) the Procuring Entity. The Contractor may, at his cost, copy, use, and obtain communication of these documents for the purposes of the Contract. They shall not, without the Procuring Entity's consent, be copied, used or communicated to a third party by the Contractor, except as necessary for the purposes of the Contract.

1.12 Confidential Details

- 1.12.1 The Contractor's and the Procuring Entity's Personnel shall disclose all such confidential and other information as may be reasonably required in order to verify compliance with the Contract and allow its proper implementation.
- 1.12.2 The Contractor's and the Procuring Entity's Personnel shall also treat the details of the Contract as private and confidential, except to the extent necessary to carry out their respective obligations under the Contract or to comply with applicable Laws. Each of them shall not publish or disclose any particulars of the Works prepared by the other Party without the previous agreement of the other Party. However, the Contractor shall be permitted to disclose any publicly available information, or information otherwise required to establish his qualifications to compete for other projects.

1.13 Compliance with Laws

- 1.131 The Contractor shall, in performing the Contract, comply with applicable Laws. Unless otherwise stated in the Particular Conditions:
- a) The Procuring Entity shall have obtained (or shall obtain) the planning, zoning, building permit or similar permission for the Permanent Works, and any other permissions described in the Specifications as having been (or to be) obtained by the Procuring Entity; and the Procuring Entity shall indemnify and hold the Contractor harmless against and from the consequences of any failure to do so; and
 - b) the Contractor shall give all notices, pay all taxes, duties and fees, and obtain all permits, licenses and approvals, as required by the Laws in relation to the execution and completion of the Works and the remedying of any defects; and the Contractor shall indemnify and hold the Procuring Entity harmless against and from the consequences of any failure to do so, unless the Contractor is impeded to accomplish these actions and shows evidence of its diligence.

1.14 Joint and Several Liability

If the Contractor constitutes (under applicable Laws) a joint venture, consortium or other unincorporated grouping of two or more persons:

- a) These persons shall be deemed to be jointly and severally liable to the Procuring Entity for the performance of the Contract;

- b) these persons shall notify the Procuring Entity of their leader who shall have authority to bind the Contractor and each of these persons; and
- c) the Contractor shall not alter its composition or legal status without the prior consent of the Procuring Entity.

1.15 Inspections and Audit by the Procuring Entity

Pursuant to paragraph 2.2 e. of Appendix B to the General Conditions, the Contractor shall permit and shall cause its subcontractors and sub-consultants to permit, the Public Procurement Regulatory Authority, Procuring Entity and/or persons appointed or designated by the Government of Kenya to inspect the Site and/or the accounts and records relating to the procurement process, selection and/or contract execution, and to have such accounts and records audited by auditors appointed by the Procuring Entity if requested by the Procuring Entity. The Contractor's and its Subcontractors' and sub-consultants' attention is drawn to Sub-Clause 15.6 (Fraud and Corruption) which provides, inter alia, that acts intended to materially impede the exercise of the Procuring Entity's inspection and audit rights constitute a prohibited practice subject to contract termination (as well as to a determination of ineligibility pursuant to the Procuring Entity's prevailing sanctions procedures).

2. THE PROCURING ENTITY

2.1 Right of Access to the Site

2.2 The Procuring Entity shall give the Contractor right of access to, and possession of, all parts of the Site within the time (or times) stated in the **Particular Conditions of Contract**. The right and possession may not be exclusive to the Contractor. If, under the Contract, the Procuring Entity is required to give (to the Contractor) possession of any foundation, structure, plant or means of access, the Procuring Entity shall do so in the time and manner stated in the Specification. However, the Procuring Entity may withhold any such right or possession until the Performance Security has been received.

2.3 If no such time is stated in the Particular Conditions of Contract, the Procuring Entity shall give the Contractor right of access to, and possession of, the Site within such times as required to enable the Contractor to proceed without disruption in accordance with the programme submitted under Sub-Clause 8.3 [Programme].

2.4 If the Contractor suffers delay and/or incurs Cost as a result of a failure by the Procuring Entity to give any such right or possession within such time, the Contractor shall give notice to the Project Manager and shall be entitled subject to Sub-Clause 20.1 [Contractor's Claims] to:

- a) an extension of time for any such delay, if completion is or will be delayed, under Sub-Clause 8.4 [Extension of Time for Completion], and
- b) payment of any such Cost-plus profit, which shall be included in the Contract Price.

2.5 After receiving this notice, the Project Manager shall proceed in accordance with Sub-Clause 3.5 [Determinations] to agree or determine these matters.

2.6 However, if and to the extent that the Procuring Entity's failure was caused by any error or delay by the Contractor, including an error in, or delay in the submission of, any of the Contractor's Documents, the Contractor shall not be entitled to such extension of time, Cost or profit.

2.2. Permits, Licenses or Approvals

2.2.1 The Procuring Entity shall provide, at the request of the Contractor, such reasonable assistance as to allow the Contractor to obtain properly:

- a) Copies of the Laws of Kenya which are relevant to the Contract but are not readily available, and
- b) Any permits, licenses or approvals required by the Laws of Kenya:
 - i) Which the Contractor is required to obtain under Sub-Clause 1.13 [Compliance with Laws],
 - ii) For the delivery of Goods, including clearance through customs, and
 - iii) For the export of Contractor's Equipment when it is removed from the Site.

2.3 Procuring Entity's Personnel

- 2.31 The Procuring Entity shall be responsible for ensuring that the Procuring Entity's Personnel and the Procuring Entity's other contractors on the Site:
- a) co-operate with the Contractor's efforts under Sub-Clause 4.6 [Co-operation], and
 - b) take actions similar to those which the Contractor is required to take under sub-paragraphs (a), (b) and (c) of Sub-Clause 4.8 [Safety Procedures] and under Sub-Clause 4.18 [Protection of the Environment].

2.4 Procuring Entity's Financial Arrangements

The Procuring Entity shall submit, before the Commencement Date and thereafter within 28 days after receiving any request from the Contractor, reasonable evidence that financial arrangements have been made and are being maintained which will enable the Procuring Entity to pay the Contract Price punctually (as estimated at that time) in accordance with Clause 14 [Contract Price and Payment]. Before the Procuring Entity makes any material change to his financial arrangements, the Procuring Entity shall give notice to the Contractor with detailed particulars.

2.5 Procuring Entity's Claims

- 2.5.1 If the Procuring Entity considers himself to be entitled to any payment under any Clause of these Conditions or otherwise in connection with the Contract, and/or to any extension of the Defects Notification Period, the Procuring Entity or the Project Manager shall give notice and particulars to the Contractor. However, notice is not required for payments due under Sub-Clause 4.19 [Electricity, Water and Gas], under Sub-Clause 4.20 [Procuring Entity's Equipment and Free-Issue Materials], or for other services requested by the Contractor.
- 2.5.2 The notice shall be given as soon as practicable and no longer than 28 days after the Procuring Entity became aware, or should have become aware, of the event or circumstances giving rise to the claim. A notice relating to any extension of the Defects Notification Period shall be given before the expiry of such period.
- 2.5.3 The particulars shall specify the Clause or other basis of the claim, and shall include substantiation of the amount and/ or extension to which the Procuring Entity considers himself to be entitled in connection with the Contract. The Project Manager shall then proceed in accordance with Sub-Clause 3.5 [Determinations] to agree or determine (i) the amount (if any) which the Procuring Entity is entitled to be paid by the Contractor, and/ or (ii) the extension (if any) of the Defects Notification Period in accordance with Sub-Clause 11.3 [Extension of Defects Notification Period].
- 2.5.4 This amount may be included as a deduction in the Contract Price and Payment Certificates. The Procuring Entity shall only be entitled to set off against or make any deduction from an amount certified in a Payment Certificate, or to otherwise claim against the Contractor, in accordance with this Sub-Clause.

3. The Project Manager

3.1 Project Manager's Duties and Authority

- 3.1.1 The Procuring Entity shall appoint the Project Manager who shall carry out the duties assigned to him in the Contract. The Project Manager's staff shall include suitably qualified Assistants and other professionals who are competent to carry out these duties. The Project Manager's Name and Address shall be provided in the **Particular Conditions of Contract**.
- 3.1.2 The Project Manager shall have no authority to amend the Contract.
- 3.1.3 The Project Manager may exercise the authority attributable to the Project Manager as specified in or necessarily to be implied from the Contract. If the Project Manager is required to obtain the approval of the Procuring Entity before exercising a specified authority, the requirements shall be as stated in the Particular Conditions. The Procuring Entity shall promptly inform the Contractor of any change to the authority attributed to the Project Manager.

3.1.4 However, whenever the Project Manager exercises a specified authority for which the Procuring Entity's approval is required, then (for the purposes of the Contract) the Procuring Entity shall be deemed to have given approval.

3.1.5 Except as otherwise stated in these Conditions:

- a) Whenever carrying out duties or exercising authority, specified in or implied by the Contract, the Project Manager shall be deemed to act for the Procuring Entity;
- b) The Project Manager has no authority to relieve either Party of any duties, obligations or responsibilities under the Contract;
- c) Any approval, check, certificate, consent, examination, inspection, instruction, notice, proposal, request, test, or similar act by the Project Manager (including absence of disapproval) shall not relieve the Contractor from any responsibility he has under the Contract, including responsibility for errors, omissions, discrepancies and non-compliances; and
- d) any act by the Project Manager in response to a Contractor's request except as otherwise expressly specified shall be notified in writing to the Contractor within 28 days of receipt.

3.1.6 The following provisions shall apply:

The Project Manager shall obtain the specific approval of the Procuring Entity before acting under the following Sub-Clauses of these Conditions:

- a) Sub-Clause 4.12: agreeing or determining an extension of time and / or additional cost.
- b) Sub-Clause 13.1: instructing a Variation, except;
 - i) In an emergency situation as determined by the Project Manager, or
 - ii) if such a Variation would increase the Accepted Contract Amount by less than the percentage specified in the **Particular Conditions of Contract**.
- c) Sub-Clause 13.3: Approving a proposal for Variation submitted by the Contractor in accordance with Sub Clause 13.1 or 13.2.
 - a) Sub-Clause 13.4: Specifying the amount payable in each of the applicable currencies.

3.1.7 Notwithstanding the obligation, asset out above, to obtain approval, if, in the opinion of the Project Manager, an emergency occurs affecting the safety of life or of the Works or of adjoining property, he may, without relieving the Contractor of any of his duties and responsibility under the Contract, instruct the Contractor to execute all such work or to do all such things as may, in the opinion of the Project Manager, be necessary to abate or reduce the risk. The Contractor shall forthwith comply, despite the absence of approval of the Procuring Entity, with any such instruction of the Project Manager. The Project Manager shall determine an addition to the Contract Price, in respect of such instruction, in accordance with Clause 13 and shall notify the Contractor accordingly, with a copy to the Procuring Entity.

3.2 Delegation by the Project Manager

3.2.1 The Project Manager may from time to time assign duties and delegate authority to assistants, and may also revoke such assignment or delegation. These assistants may include a resident Project Manager, and/or independent inspectors appointed to inspect and/or test items of Plant and/or Materials. The assignment, delegation or revocation shall be in writing and shall not take effect until copies have been received by both Parties. However, unless otherwise agreed by both Parties, the Project Manager shall not delegate the authority to determine any matter in accordance with Sub-Clause 3.5 [Determinations].

3.3.2 Each assistant, to whom duties have been assigned or authority has been delegated, shall only be authorized to issue instructions to the Contractor to the extent defined by the delegation. Any approval, check, certificate, consent, examination, inspection, instruction, notice, proposal, request, test, or similar act by an assistant, in accordance with the delegation, shall have the same effect as though the act had been an act of the Project Manager. However:

- b) Any failure to disapprove any work, Plant or Materials shall not constitute approval, and shall therefore not prejudice the right of the Project Manager to reject the work, Plant or Materials;
- c) If the Contractor questions any determination or instruction of an assistant, the Contractor may refer the matter to the Project Manager, who shall promptly confirm, reverse or vary the determination or instruction.

3.3 Instructions of the Project Manager

3.3.1 The Project Manager may issue to the Contractor (at any time) instructions and additional or modified Drawings which may be necessary for the execution of the Works and the remedying of any defects, all in accordance with the Contract. The Contractor shall only take instructions from the Project Manager, or from an assistant to whom the appropriate authority has been delegated under this Clause. If an instruction constitutes a Variation, Clause 13 [Variations and Adjustments] shall apply.

3.3.2 The Contractor shall comply with the instructions given by the Project Manager or delegated assistant, on any matter related to the Contract. Whenever practicable, their instructions shall be given in writing. If the Project Manager or a delegated assistant:

- d) Gives an oral instruction,
- e) receives a written confirmation of the instruction, from (or on behalf of) the Contractor, within two working days after giving the instruction, and
- f) does not reply by issuing a written rejection and/ or instruction within two working days after receiving the confirmation, then the confirmation shall constitute the written instruction of the Project Manager or delegated assistant (as the case may be).

3.4 Replacement of the Project Manager

If the Procuring Entity intends to replace the Project Manager, the Procuring Entity shall, not less than 21 days before the intended date of replacement, give notice to the Contractor of the name, address and relevant experience of the intended replacement Project Manager. If the Contractor considers the intended replacement Project Manager to be unsuitable, he has the right to raise objection against him by notice to the Procuring Entity, with supporting particulars, and the Procuring Entity shall give full and fair consideration to this objection.

3.5 Determinations

3.5.1 Whenever these Conditions provide that the Project Manager shall proceed in accordance with this Sub-Clause

3.5 to agree or determine any matter, the Project Manager shall consult with each Party in an endeavor to reach agreement. If agreement is not achieved, the Project Manager shall make a fair determination in accordance with the Contract, taking due regard of all relevant circumstances.

3.5.2 The Project Manager shall give notice to both Parties of each agreement or determination, with supporting particulars, within 28 days from the receipt of the corresponding claim or request except when otherwise specified. Each Party shall give effect to each agreement or determination unless and until revised under Clause 20 [Claims, Disputes and Arbitration].

4. The Contractor

4.1 Contractor's General Obligations

4.1 The Contractor shall design (to the extent specified in the Contract), execute and complete the Works in accordance with the Contract and with the Project Manager's instructions, and shall remedy any defects in the Works.

4.1.1 The Contractor shall provide the Plant and Contractor's Documents specified in the Contract, and all Contractor's Personnel, Goods, consumables and other things and services, whether of a temporary or permanent nature, required in and for this design, execution, completion and remedying of defects.

4.1.2 All equipment, material, and services to be incorporated in or required for the Works shall have their origin in any eligible source country.

4.1.3 The Contractor shall be responsible for the adequacy, stability and safety of all Site operations and of all methods of construction. Except to the extent specified in the Contract, the Contractor (I) shall be responsible for all Contractor's Documents, Temporary Works, and such design of each item of Plant and Materials as is required for the item to be in accordance with the Contract, and (ii) shall not otherwise be

responsible for the design or specification of the Permanent Works.

- 4.1.4 The Contractor shall, whenever required by the Project Manager, submit details of the arrangements and methods which the Contractor proposes to adopt for the execution of the Works. No significant alteration to these arrangements and methods shall be made without this having previously been notified to the Project Manager.
- 4.1.5 If the Contract specifies that the Contractor shall design any part of the Permanent Works, then unless otherwise stated in the Particular Conditions:
- a) The Contractor shall submit to the Project Manager the Contractor's Documents for this part in accordance with the procedures specified in the Contract;
 - b) These Contractor's Documents shall be in accordance with the Specification and Drawings, shall be written in the language for communications defined in Sub-Clause 1.4 [Law and Language], and shall include additional information required by the Project Manager to add to the Drawings for co-ordination of each Party's designs;
 - c) The Contractor shall be responsible for this part and it shall, when the Works are completed, befit for such purposes for which the part is intended as are specified in the Contract; and
 - d) prior to the commencement of the Tests on Completion, the Contractor shall submit to the Project Manager the "as-built" documents and, if applicable, operation and maintenance manuals in accordance with the Specification and in sufficient detail for the Procuring Entity to operate, maintain, dismantle, reassemble, adjust and repair this part of the Works. Such part shall not be considered to be completed for the purposes of taking-over under Sub-Clause 10.1 [Taking Over of the Works and Sections] until these documents and manuals have been submitted to the Project Manager.

4.2 Performance Security

- 4.2.1 The Contractor shall obtain (at his cost) a Performance Security for proper performance, in the amount stated in the **Particular Conditions of Contract** and denominated in the currency (I e s) of the Contract or in a freely convertible currency acceptable to the Procuring Entity. If an amount is not stated in the Particular Conditions of Contract, this Sub-Clause shall not apply.
- 4.2.2 The Contractor shall deliver the Performance Security to the Procuring Entity within 28 days after receiving the Letter of Acceptance, and shall send a copy to the Project Manager. The Performance Security shall be issued by a reputable bank selected by the Contractor, and shall be in the form annexed to the Particular Conditions, as stipulated by the Procuring Entity in the Particular Conditions of Contract, or in another form approved by the Procuring Entity.
- 4.2.3 The Contractor shall ensure that the Performance Security is valid and enforceable until the Contractor has executed and completed the Works and remedied any defects. If the terms of the Performance Security specify its expiry date, and the Contractor has not become entitled to receive the Performance Certificate by the date 28 days prior to the expiry date, the Contractor shall extend the validity of the Performance Security until the Works have been completed and any defects have been remedied.
- 4.2.4 The Procuring Entity shall not make a claim under the Performance Security, except for amounts to which the Procuring Entity is entitled under the Contract.
- 4.2.5 The Procuring Entity shall indemnify and hold the Contractor harmless against and from all damages, losses and expenses (including legal fees and expenses) resulting from a claim under the Performance Security to the extent to which the Procuring Entity was not entitled to make the claim.
- 4.2.6 The Procuring Entity shall return the Performance Security to the Contractor within 14 days after receiving a copy of the Taking-Over Certificate.
- 4.2.7 Without limitation to the provisions of the rest of this Sub-Clause, whenever the Project Manager determines an addition or a reduction to the Contract Price as a result of a change in cost and/ or legislation, or as a result of a Variation, amounting to more than 25 percent of the portion of the Contract Price payable in a specific currency, the Contractor shall at the Project Manager's request promptly increase, or may decrease, as the case may be, the value of the Performance Security in that currency by an equal percentage.

4.3 Contractor's Representative

- 4.3.1 The Contractor shall appoint the Contractor's Representative and shall give him all authority necessary to act on the Contractor's behalf under the Contract. The Contractor's Representative's Name and Address shall be provided in the **Particular Conditions of Contract**.
- 4.3.2 Unless the Contractor's Representative **is named in the Contract**, the Contractor shall, prior to the Commencement Date, submit to the Project Manager for consent the name and particulars of the person the Contract or proposes to appoint as Contractor's Representative. If consent is withheld or subsequently revoked in terms of Sub-Clause 6.9 [Contractor's Personnel], or if the appointed person fails to act as Contractor's Representative, the Contractor shall similarly submit the name and particulars of another suitable person for such appointment.
- 4.3.3 The Contractor shall not, without the prior consent of the Project Manager, revoke the appointment of the Contractor's Representative or appoint a replacement.
- 4.3.4 The whole time of the Contractor's Representative shall be given to directing the Contractor's performance of the Contract. If the Contractor's Representative is to be temporarily absent from the Site during the execution of the Works, a suitable replacement person shall be appointed, subject to the Project Manager's prior consent, and the Project Manager shall be notified accordingly.
- 4.3.5 The Contractor's Representative shall, on behalf of the Contractor, receive instructions under Sub-Clause 3.3 [Instructions of the Project Manager].
- 4.3.6 The Contractor's Representative may delegate any powers, functions and authority to any competent person, and may at any time revoke the delegation. Any delegation or revocation shall not take effect until the Project Manager has received prior notice signed by the Contractor's Representative, naming the person and specifying the powers, functions and authority being delegated or revoked.
- 4.3.7 The Contractor's Representative shall be fluent in the language for communications defined in Sub-Clause 1.4 [Law and Language]. If the Contractor's Representative's delegates are not fluent in the said language, the Contractor shall make competent interpreters available during all working hours in a number deemed sufficient by the Project Manager.

4.4 Subcontractors

- 4.4.1 The Contractor shall not subcontract the whole of the Works.
- 4.4.1 The Contractor shall be responsible for the acts or defaults of any Subcontractor, his agents or employees, as if they were the acts or defaults of the Contractor. Unless otherwise stated in the Particular Conditions:
- e) The Contractor shall not be required to obtain consent to suppliers solely of Materials, or to a subcontract for which the Subcontractor is named in the Contract;
 - f) The prior consent of the Project Manager shall be obtained to other proposed Subcontractors;
 - g) the Contractor shall give the Project Manager not less than 28 days' notice of the intended date of the commencement of each Subcontractor's work, and of the commencement of such work on the Site; and
 - h) each subcontract shall include provisions which would entitle the Procuring Entity to require the subcontract to be assigned to the Procuring Entity under Sub-Clause 4.5 [Assignment of Benefit of Subcontract] (I for when applicable) or in the event of termination under Sub-Clause 15.2 [Termination by Procuring Entity].
- 4.4.3 The Contractor shall ensure that the requirements imposed on the Contractor by Sub-Clause 1.12 [Confidential Details] apply equally to each Subcontractor.
- 4.4.4 Where practicable, the Contractor shall give fair and reasonable opportunity for contractors from Kenya to be appointed as Subcontractors.

4.5 Assignment of Benefit of Subcontract

4.5.1 If a Subcontractor's obligations extend beyond the expiry date of the relevant Defects Notification Period and the Project Manager, prior to this date, instructs the Contractor to assign the benefit of such obligations to the

Procuring Entity, then the Contractor shall do so. Unless otherwise stated in the assignment, the Contractor shall have no liability to the Procuring Entity for the work carried out by the Subcontractor after the assignment takes effect.

4.6 Co-operation

4.6.1 The Contractor shall, as specified in the Contract or as instructed by the Project Manager, allow appropriate opportunities for carrying out work to:

- i) The Procuring Entity's Personnel,
- j) Any other contractors employed by the Procuring Entity, and
- k) The personnel of any legally constituted public authorities, who may be employed in the execution on or near the Site of any work not included in the Contract.

4.6.2 Any such instruction shall constitute a Variation if and to the extent that it causes the Contractor to suffer delays and/or to incur Unforeseeable Cost. Services for these personnel and other contractors may include the use of Contractor's Equipment, Temporary Works or access arrangements which are the responsibility of the Contractor.

4.6.3 If, under the Contract, the Procuring Entity is required to give to the Contractor possession of any foundation, structure, plant or means of access in accordance with Contractor's Documents, the Contractor shall submit such documents to the Project Manager in the time and manner stated in the Specification.

4.7 Setting Out

4.7.1 The Contractor shall set out the Works in relation to original points, lines and levels of reference specified in the Contract notified by the Project Manager. The Contractor shall be responsible for the correct positioning of all parts of the Works, and shall rectify any error in the positions, levels, dimensions or alignment of the Works.

4.7.2 The Procuring Entity shall be responsible for any errors in these specified or notified items of reference, but the Contractor shall use reasonable efforts to verify their accuracy before they are used.

4.7.3 If the Contractor suffers delay and/or incurs Cost from executing work which was necessitated by an error in these items of reference, and an experienced contractor could not reasonably have discovered such error and avoided this delay and/or Cost, the Contractor shall give notice to the Project Manager and shall be entitled subject to Sub-Clause 20.1 [Contractor's Claims] to:

- l) an extension of time for any such delay, if completion is or will be delayed, under Sub-Clause 8.4 [Extension of Time for Completion], and
- m) payment of any such Cost-plus profit, which shall be included in the Contract Price.

4.7.4 After receiving this notice, the Project Manager shall proceed in accordance with Sub-Clause 3.5 [Determinations] to agree or determine (i) whether and (if so) to what extent the error could not reasonably have been discovered, and (ii) the matters described in sub-paragraphs (a) and (b) above related to this.

4.8 Safety Procedures

4.8.1 The Contractor shall:

- a) Comply with all applicable safety regulations,
- b) Take care for the safety of all persons entitled to be on the Site,
- c) Use reasonable efforts to keep the Site and Works clear of unnecessary obstruction so as to avoid danger to these persons,
- d) provide fencing, lighting, guarding and watching of the Works until completion and taking over under Clause 10 [Procuring Entity's Taking Over], and
- e) provide any Temporary Works (including roadways, footways, guards and fences) which may be necessary, because of the execution of the Works, for the use and protection of the public and of owners and occupiers of adjacent land.

4.9 Quality Assurance

- 4.9.1 The Contractor shall institute a quality assurance system to demonstrate compliance with the requirements of the Contract. The system shall be in accordance with the details stated in the Contract. The Project Manager shall be entitled to audit any aspect of the system.
- 4.9.2 Details of all procedures and compliance documents shall be submitted to the Project Manager for information before each design and execution stage is commenced. When any document of a technical nature is issued to the Project Manager, evidence of the prior approval by the Contractor himself shall be apparent on the document itself.
- 4.9.3 Compliance with the quality assurance system shall not relieve the Contractor of any of his duties, obligations or responsibilities under the Contract.

4.10 Site Data

- 4.10.1 The Procuring Entity shall have made available to the Contractor for his information, prior to the Base Date, all relevant data in the Procuring Entity's possession on sub-surface and hydrological conditions at the Site, including environmental aspects. The Procuring Entity shall similarly make available to the Contractor all such data which come into the Procuring Entity's possession after the Base Date. The Contractor shall be responsible for interpreting all such data.
- 4.10.1 To the extent which was practicable (taking account of cost and time), the Contractor shall be deemed to have obtained all necessary information as to risks, contingencies and other circumstances which may influence or affect the Tender or Works. To the same extent, the Contractor shall be deemed to have inspected and examined the Site, its surroundings, the above data and other available information, and to have been satisfied before submitting the Tender as to all relevant matters, including (without limitation):
- n) The form and nature of the Site, including sub-surface conditions,
 - o) The hydrological and climatic conditions,
 - p) The extent and nature of the work and Goods necessary for the execution and completion of the Works and the remedying of any defects,
 - q) The Laws, procedures and labor practices of Kenya, and
 - r) the Contractor's requirements for access, accommodation, facilities, personnel, power, transport, water and other services.

4.11 Sufficiency of the Accepted Contract Amount

- 4.11.1 The Contractor shall be deemed to:
- s) Have satisfied himself as to the correctness and sufficiency of the Accepted Contract Amount, and
 - t) have based the Accepted Contract Amount on the data, interpretations, necessary information, inspections, examinations and satisfaction as to all relevant matters referred to in Sub-Clause 4.10 [Site Data].
- 4.11.2 Unless otherwise stated in the Contract, the Accepted Contract Amount covers all the Contractor's obligations under the Contract (including those under Provisional Sums, if any) and all things necessary for the proper execution and completion of the Works and the remedying of any defects.

4.12 Unforeseeable Physical Conditions

- 4.12.1 In this Sub-Clause, "physical conditions" means natural physical conditions and man-made and other physical obstructions and pollutants, which the Contractor encounters at the Site when executing the Works, including sub-surface and hydrological conditions but excluding climatic conditions.
- 4.12.2 If the Contractor encounters adverse physical conditions which he considers to have been Unforeseeable, the Contractor shall give notice to the Project Manager as soon as practicable.
- 4.12.3 This notice shall describe the physical conditions, so that they can be inspected by the Project Manager, and shall set out the reasons why the Contractor considers them to be Unforeseeable. The Contractor shall

continue executing the Works, using such proper and reasonable measures as are appropriate for the physical conditions, and shall comply with any instructions which the Project Manager may give. If an instruction constitutes a Variation, Clause 13 [Variations and Adjustments] shall apply.

- 4.12.4 If and to the extent that the Contractor encounters physical conditions which are Unforeseeable, gives such a notice, and suffers delay and/or incurs Cost due to these conditions, the Contractor shall be entitled subject to notice under Sub-Clause 20.1 [Contractor's Claims] to:
- a) an extension of time for any such delay, if completion is or will be delayed, under Sub-Clause 8.4 [Extension of Time for Completion], and
 - b) payment of any such Cost, which shall be included in the Contract Price.
- 4.12.5 Upon receiving such notice and inspecting and/or investigating these physical conditions, the Project Manager shall proceed in accordance with Sub-Clause 3.5 [Determinations] to agree or determine (i) whether and (if so) to what extent these physical conditions were Unforeseeable, and (ii) the matters described in sub-paragraphs (a) and (b) above related to this extent.
- 4.12.6 However, before additional Cost is finally agreed or determined under sub-paragraph (ii), the Project Manager may also review whether other physical conditions in similar parts of the Works (if any) were more favorable than could reasonably have been foreseen when the Contractor submitted the Tender. If and to the extent that these more favorable conditions were encountered, the Project Manager may proceed in accordance with Sub-Clause 3.5 [Determinations] to agree or determine the reductions in Cost which were due to these conditions, which may be included (as deductions) in the Contract Price and Payment Certificates. However, the net effect of all adjustments under sub-paragraph (b) and all these reductions, for all the physical conditions encountered in similar parts of the Works, shall not result in a net reduction in the Contract Price.
- 4.12.7 The Project Manager shall take account of any evidence of the physical conditions foreseen by the Contractor when submitting the Tender, which shall be made available by the Contractor, but shall not be bound by the Contractor's interpretation of any such evidence.

4.13 Rights of Way and Facilities

Unless otherwise specified in the Contract the Procuring Entity shall provide effective access to and possession of the Site including special and/or temporary rights-of-way which are necessary for the Works. The Contractor shall obtain, at his risk and cost, any additional rights of way or facilities outside the Site which he may require for the purposes of the Works.

4.14 Avoidance of Interference

- 4.14.5 The Contractor shall not interfere unnecessarily or improperly with:
- a) The convenience of the public, or
 - b) The access to and use and occupation of all roads and foot paths, irrespective of whether they are public or in the possession of the Procuring Entity or of others.
- 4.14.6 The Contractor shall indemnify and hold the Procuring Entity harmless against and from all damages, losses and expenses (including legal fees and expenses) resulting from any such unnecessary or improper interference.

4.15 Access Route

- 4.15.5 The Contractor shall be deemed to have been satisfied as to the suitability and availability of access routes to the Site at Base Date. The Contractor shall use reasonable efforts to prevent any road or bridge from being damaged by the Contractor's traffic or by the Contractor's Personnel. These efforts shall include the proper use of appropriate vehicles and routes.
- 4.15.6 Except as otherwise stated in these Conditions:
- a) The Contractor shall (as between the Parties) be responsible for any maintenance which may be required for his use of access routes;
 - b) the Contractor shall provide all necessary signs or directions along access routes, and shall obtain



any permission which may be required from the relevant authorities for his use of routes, signs and directions;

- c) the Procuring Entity shall not be responsible for any claims which may arise from the use or otherwise of any access route;
- d) the Procuring Entity does not guarantee the suitability or availability of particular access routes; and
- e) Costs due to non-suitability or non-availability, for the use required by the Contractor, of access routes shall be borne by the Contractor.

4.16 Transport of Goods

Unless otherwise stated in the Particular Conditions:

- a) The Contractor shall give the Project Manager not less than 21 days' notice of the date on which any Plant or a major item of other Goods will be delivered to the Site;
- b) the Contractor shall be responsible for packing, loading, transporting, receiving, unloading, storing and protecting all Goods and other things required for the Works; and
- c) the Contractor shall indemnify and hold the Procuring Entity harmless against and from all damages, losses and expenses (including legal fees and expenses) resulting from the transport of Goods, and shall negotiate and pay all claims arising from their transport.

4.17 Contractor's Equipment

The Contractor shall be responsible for all Contractor's Equipment. When brought on to the Site, Contractor's Equipment shall be deemed to be exclusively intended for the execution of the Works. The Contractor shall not remove from the Site any major items of Contractor's Equipment without the consent of the Project Manager. However, consent shall not be required for vehicles transporting Goods or Contractor's Personnel off Site.

4.18 Protection of the Environment

- 4.18.5 The Contractor shall take all reasonable steps to protect the environment (both on and off the Site) and to limit damage and nuisance to people and property resulting from pollution, noise and other results of his operations.
- 4.18.6 The Contractor shall ensure that emissions, surface discharges and effluent from the Contractor's activities shall not exceed the values stated in the Specification or prescribed by applicable Laws.

4.19 Electricity, Water and Gas

- 4.19.5 The Contractor shall, except as stated below, be responsible for the provision of all power, water and other services he may require for his construction activities and to the extent defined in the Specifications, for the tests.
- 4.19.6 The Contractor shall be entitled to use for the purposes of the Works such supplies of electricity, water, gas and other services as may be available on the Site and of which details and prices are given in the Specifications. The Contractor shall, at his risk and cost, provide any apparatus necessary for his use of these services and for measuring the quantities consumed.
- 4.19.7 The quantities consumed and the amounts due (at these prices) for such services shall be agreed or determined by the Project Manager in accordance with Sub-Clause 2.5 [Procuring Entity's Claims] and Sub-Clause 3.5 [Determinations]. The Contractor shall pay these amounts to the Procuring Entity.

4.20 Procuring Entity's Equipment and Free-Issue Materials

- 4.20.5 The Procuring Entity shall make the Procuring Entity's Equipment (if any) available for the use of the Contractor in the execution of the Works in accordance with the details, arrangements and prices stated in the Specification. Unless otherwise stated in the Specification:
 - a) The Procuring Entity shall be responsible for the Procuring Entity's Equipment, except that
 - b) the Contractor shall be responsible for each item of Procuring Entity's Equipment whilst any of the Contractor's Personnel is operating it, driving it, directing it or in possession or control of it.
- 4.20.6 The appropriate quantities and the amounts due (at such stated prices) for the use of Procuring Entity's Equipment shall be agreed or determined by the Project Manager in accordance with Sub-Clause 2.5

[Procuring Entity's Claims] and Sub-Clause 3.5 [Determinations]. The Contractor shall pay these amounts to the Procuring Entity.

- 4.20.7 The Procuring Entity shall supply, free of charge, the “free-issue materials” (if any) in accordance with the details stated in the Specification. The Procuring Entity shall, at his risk and cost, provide these materials at the time and place specified in the Contract. The Contractor shall then visually inspect them, and shall promptly give notice to the Project Manager of any shortage, defect or default in these materials. Unless otherwise agreed by both Parties, the Procuring Entity shall immediately rectify the notified shortage, defect or default.
- 4.20.8 After this visual inspection, the free-issue materials shall come under the care, custody and control of the Contractor. The Contractor's obligations of inspection, care, custody and control shall not relieve the Procuring Entity of liability for any shortage, defect or default not apparent from a visual inspection.

4.21 Progress Reports

- 4.21.1 Unless otherwise stated in the Particular Conditions, monthly progress reports shall be prepared by the Contractor and submitted to the Project Manager in six copies. The first report shall cover the period up to the end of the first calendar month following the Commencement Date. Reports shall be submitted monthly thereafter, each within 7 days after the last day of the period to which it relates.
- 4.21.2 Reporting shall continue until the Contractor has completed all work which is known to be outstanding at the completion date stated in the Taking-Over Certificate for the Works. Each report shall include:
- a) charts and detailed descriptions of progress, including each stage of design (if any), Contractor's Documents, procurement, manufacture, delivery to Site, construction, erection and testing; and including these stages for work by each nominated Subcontractor (as defined in Clause 5 [Nominated Subcontractors]),
 - b) photographs showing the status of manufacture and of progress on the Site;
 - c) for the manufacture of each main item of Plant and Materials, the name of the manufacturer, manufacture location, percentage progress, and the actual or expected dates of:
 - i) commencement of manufacture,
 - ii) Contractor's inspections,
 - iii) tests, and
 - iv) shipment and arrival at the Site;
 - d) the details described in Sub-Clause 6.10 [Records of Contractor's Personnel and Equipment];
 - e) copies of quality assurance documents, test results and certificates of Materials;
 - f) list of notices given under Sub-Clause 2.5 [Procuring Entity's Claims] and notices given under Sub-Clause 20.1 [Contractor's Claims];
 - g) safety statistics, including details of any hazardous incidents and activities relating to environmental aspects and public relations; and
 - h) comparisons of actual and planned progress, with details of any events or circumstances which may jeopardize the completion in accordance with the Contract, and the measures being (or to be) adopted to overcome delays.

4.22 Security of the Site

Unless otherwise stated in the Particular Conditions:

- a) The Contractor shall be responsible for keeping un authorized persons off the Site, and
- b) Authorized persons shall be limited to the Contractor's Personnel and the Procuring Entity's Personnel; and to any other personnel notified to the Contractor, by the Procuring Entity or the Project Manager, as authorized personnel of the Procuring Entity's other contractors on the Site.

4.23 Contractor's Operations on Site

- 4.23.1 The Contractor shall confine his operations to the Site, and to any additional areas which may be obtained

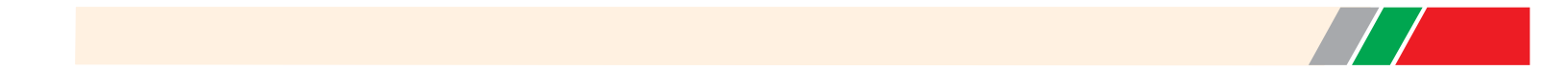

by the Contractor and agreed by the Project Manager as additional working areas. The Contractor shall take all necessary precautions to keep Contractor's Equipment and Contractor's Personnel within the Site and these additional areas, and to keep them off adjacent land.

4.23.2 During the execution of the Works, the Contractor shall keep the Site free from all unnecessary obstruction, and shall store or dispose of any Contractor's Equipment or surplus materials. The Contractor shall clear away and remove from the Site any wreckage, rubbish and Temporary Works which are no longer required.

4.23.2 Upon the issue of a Taking-Over Certificate, the Contractor shall clear away and remove, from that part of the Site and Works to which the Taking-Over Certificate refers, all Contractor's Equipment, surplus material, wreckage, rubbish and Temporary Works. The Contractor shall leave that part of the Site and the Works in a clean and safe condition. However, the Contractor may retain on Site, during the Defects Notification Period, such Goods as are required for the Contractor to fulfil obligations under the Contract.

4.24 Fossils

4.24.1 All fossils, coins, articles of value or antiquity, and structures and other remains or items of geological or archaeological interest found on the Site shall be placed under the care and authority of the Procuring Entity. The Contractor shall take reasonable precautions to prevent Contractor's Personnel or other persons from removing or damaging any of these findings.

4.24.2 The Contractor shall, upon discovery of any such finding, promptly give notice to the Project Manager, who shall issue instructions for dealing with it. If the Contractor suffers delay and/or incurs Cost from complying with the instructions, the Contractor shall give a further notice to the Project Manager and shall be entitled subject to Sub-Clause 20.1 [Contractor's Claims] to:

- i) an extension of time for any such delay, if completion is or will be delayed, under Sub-Clause 8.4 [Extension of Time for Completion], and
- j) payment of any such Cost, which shall be included in the Contract Price.

After receiving this further notice, the Project Manager shall proceed in accordance with Sub-Clause 3.5 [Determinations] to agree or determine these matters.

5 Nominated Subcontractors

5.1 Definition of "nominated Subcontractor"

In the Contract, "nominated Subcontractor" means a Subcontractor:

- a) Who is stated in the Contract as being a nominated Subcontractor, or
- b) whom the Project Manager, under Clause 13 [Variations and Adjustments], instructs the Contractor to employ as a Subcontractor subject to Sub-Clause 5.2 [Objection to Notification].

5.2 Objection to Nomination

The Contractor shall not be under any obligation to employ a nominated Subcontractor against whom the Contractor raises reasonable objection by notice to the Project Manager as soon as practicable, with supporting particulars. An objection shall be deemed reasonable if it arises from (among other things) any of the following matters, unless the Procuring Entity agrees in writing to indemnify the Contractor against and from the consequences of the matter:

- a) there are reasons to believe that the Subcontractor does not have sufficient competence, resources or financial strength;
- b) the nominated Subcontractor does not accept to indemnify the Contractor against and from any negligence or misuse of Goods by the nominated Subcontractor, his agents and employees; or
- c) the nominated Subcontractor does not accept to enter into a subcontract which specifies that, for the subcontracted work (including design, if any), the nominated Subcontractor shall:
 - i) undertake to the Contractor such obligations and liabilities as will enable the Contractor to discharge his obligations and liabilities under the Contract;
 - ii) indemnify the Contractor against and from all obligations and liabilities arising under or in connection with the Contract and from the consequences of any failure by the Subcontractor to perform these obligations or to fulfil these liabilities, and
 - iii) be paid only if and when the Contractor has received from the Procuring Entity payments for sums due under the Subcontract referred to under Sub-Clause 5.3 [Payment to nominated

Subcontractors].

5.3 Payments to nominated Subcontractors

The Contractor shall pay to the nominated Subcontractor the amounts shown on the nominated Subcontractor's invoices approved by the Contractor which the Project Manager certifies to be due in accordance with the subcontract. These amounts plus other charges shall be included in the Contract Price in accordance with sub-paragraph (b) of Sub-Clause 13.5 [Provisional Sums], except as stated in Sub-Clause 5.4 [Evidence of Payments].

5.4 Evidence of Payments

5.4.1 Before issuing a Payment Certificate which includes an amount payable to a nominated Subcontractor, the Project Manager may request the Contractor to supply reasonable evidence that the nominated Subcontractor has received all amounts due in accordance with previous Payment Certificates, less applicable deductions for retention or otherwise. Unless the Contractor:

- a) Submits this reasonable evidence to the Project Manager, or
- b)
 - i) satisfies the Project Manager in writing that the Contractor is reasonably entitled to withhold or refuse to pay these amounts, and
 - ii) submits to the Project Manager reasonable evidence that the nominated Subcontractor has been notified of the Contractor's entitlement, then the Procuring Entity may (at his sole discretion) pay, direct to the nominated Subcontractor, part or all of such amounts previously certified (less applicable deductions) as are due to the nominated Subcontractor and for which the Contractor has failed to submit the evidence described in sub-paragraphs (a) or (b) above. The Contractor shall then repay, to the Procuring Entity, the amount which the nominated Subcontractor was directly paid by the Procuring Entity.

6 Staff and Labour

6.1 Engagement of Staff and Labour

6.1.1 Except as otherwise stated in the Specification, the Contractor shall decide for the engagement of all staff and labor, local or otherwise, and for their payment, feeding, transport, and, when appropriate, housing. The Contractor is encouraged, to the extent practicable and reasonable, to employ staff and labor with appropriate qualifications and experience from sources within Kenya.

6.2 Rates of Wages and Conditions of Labour

6.2.1 The Contractor shall pay rates of wages, and observe conditions of labor, which are not lower than those established for the trade or industry where the work is carried out. If no established rates or conditions are applicable, the Contractor shall pay rates of wages and observe conditions which are not lower than the general level of wages and conditions observed locally by Procuring Entities whose trade or industry is similar to that of the Contractor.

6.2.2 The Contractor shall inform the Contractor's Personnel about their liability to pay personal income taxes in Kenya in respect of such of their salaries, wages, allowances and any benefits as are subject to tax under the Laws of Kenya for the time being in force, and the Contractor shall perform such duties in regard to such deductions thereof as may be imposed on him by such Laws.

6.3 Persons in the Service of Procuring Entity

The Contractor shall not recruit, or attempt to recruit, staff and Labour from amongst the Procuring Entity's Personnel.

6.4 Labour Laws

6.4.1 The Contractor shall comply with all the relevant labour Laws applicable to the Contractor's Personnel, including Laws relating to their employment, health, safety, welfare, immigration and emigration, and shall allow them all their legal rights.

6.4.2 The Contractor shall require his employees to obey all applicable Laws, including those concerning safety

at work.

6.5 Working Hours

No work shall be carried out on the Site on locally recognized days of rest, or outside the normal working hours stated in the **Particular Conditions of Contract**, unless:

- a) Otherwise stated in the Contract,
- b) The Project Manager gives consent, or
- c) The work is unavoidable, or necessary for the protection of life or property or for the safety of the Works, in which case the Contractor shall immediately advise the Project Manager.

6.6 Facilities for Staff and Labour

Except as otherwise stated in the Specification, the Contractor shall provide and maintain all necessary accommodation and welfare facilities for the Contractor's Personnel. The Contractor shall also provide facilities for the Procuring Entity's Personnel as stated in the Specifications. The Contractor shall not permit any of the Contractor's Personnel to maintain any temporary or permanent living quarters within the structures forming part of the Permanent Works.

6.7 Health and Safety

- 6.7.1 The Contractor shall at all times take all reasonable precautions to maintain the health and safety of the Contractor's Personnel. In collaboration with local health authorities, the Contractor shall ensure that medical staff, first aid facilities, sick bay and ambulance service are available at all times at the Site and at any accommodation for Contractor's and Procuring Entity's Personnel, and that suitable arrangements are made for all necessary welfare and hygiene requirements and for the prevention of epidemics.
- 6.7.2 The Contractor shall appoint an accident prevention officer at the Site, responsible for maintaining safety and protection against accidents. This person shall be qualified for this responsibility, and shall have the authority to issue instructions and take protective measures to prevent accidents. Throughout the execution of the Works, the Contractor shall provide whatever is required by this person to exercise this responsibility and authority.
- 6.7.3 The Contractor shall send, to the Project Manager, details of any accident as soon as practicable after its occurrence. The Contractor shall maintain records and make reports concerning health, safety and welfare of persons, and damage to property, as the Project Manager may reasonably require.
- 6.7.4 The Contractor shall conduct an awareness programme on HIV and other sexually transmitted diseases via an approved service provider, and shall undertake such other measures as are specified in this Contract to reduce the risk of the transfer of these diseases between and among the Contractor's Personnel and the local community, to promote early diagnosis and to assist affected individuals.

6.8 Contractor's Superintendence

- 6.8.1 Throughout the execution of the Works, and as long thereafter as is necessary to fulfil the Contractor's obligations, the Contractor shall provide all necessary superintendencies to plan, arrange, direct, manage, inspect and test the work.
- 6.8.2 Superintendence shall be given by a sufficient number of persons having adequate knowledge of the language for communications (defined in Sub-Clause 1.4 [Law and Language]) and of the operations to be carried out (including the methods and techniques required, the hazards likely to be countered and methods of preventing accidents), for the satisfactory and safe execution of the Works.

6.9 Contractor's Personnel

- 6.9.1 The Contractor's Personnel shall be appropriately qualified, skilled and experienced in the respective trades or occupations. The Contractor's Key personnel shall be named in the **Particular Conditions of Contract**. The Project Manager may require the Contractor to remove (or cause to be removed) any person employed on the Site or Works, including the Contractor's Representative if applicable, who:
 - a) Persists in any misconduct or lack of care,
 - b) Carries out duties incompetently or negligently,

- c) Fails to conform with any provisions of the Contract,
- d) Persists in any conduct which is prejudicial to safety, health, or the protection of the environment, or
- e) based on reasonable evidence, is determined to have engaged in Fraud and Corruption during the execution of the Works.

6.9.2 If appropriate, the Contractor shall then appoint (or cause to be appointed) a suitable replacement person.

6.10 Records of Contractor's Personnel and Equipment

The Contractor shall submit, to the Project Manager, details showing the number of each class of Contractor's Personnel and of each type of Contractor's Equipment on the Site. Details shall be submitted each calendar month, in a form approved by the Project Manager, until the Contractor has completed all work which is known to be outstanding at the completion date stated in the Taking-Over Certificate for the Works.

6.11 Disorderly Conduct

The Contractor shall at all times take all reasonable precautions to prevent any unlawful, riotous or disorderly conduct by or amongst the Contractor's Personnel, and to preserve peace and protection of persons and property on and near the Site.

6.12 Foreign Personnel

6.12.1 The Contractor may bring into Kenya any foreign personnel who are necessary for the execution of the Works to the extent allowed by the applicable Laws. The Contractor shall ensure that these personnel are provided with the required residence visas and work permits. The Procuring Entity will, if requested by the Contractor, use his Lowest endeavors in a timely and expeditious manner to assist the Contractor in obtaining any local, state, national or government permission required for bringing in the Contractor's personnel.

6.12.2 The Contractor shall be responsible for the return of these personnel to the place where they were recruited or to their domicile. In the event of the death in Kenya of any of these personnel or members of their families, the Contractor shall similarly be responsible for making the appropriate arrangements for their return or burial.

6.13 Supply of Water

The Contractor shall, having regard to local conditions, provide on the Site an adequate supply of drinking and other water for the use of the Contractor's Personnel.

6.14 Measures against Insect and Pest Nuisance

The Contractor shall at all times take the necessary precautions to protect the Contractor's Personnel employed on the Site from insect and pest nuisance, and to reduce the danger to their health. The Contractor shall comply with all the regulations of the local health authorities, including use of appropriate insecticide.

6.15 Alcoholic Liquor or Drugs

The Contractor shall not, otherwise than in accordance with the Laws of Kenya, on site, import, sell, give, barter or otherwise dispose of any alcoholic liquor or drugs, or permit or allow importation, sale, gift, barter or disposal thereof by Contractor's Personnel.

6.16 Prohibition of Forced or Compulsory Labour

The Contractor shall not employ forced labour, which consists of any work or service, not voluntarily performed, that is exacted from an individual under threat of force or penalty, and includes any kind of involuntary or compulsory labour, such as indentured labour, bonded labour or similar labour-contracting arrangements.

6.17 Prohibition of Harmful Child Labour

The Contractor shall not employ children in a manner that is economically exploitative, or is likely to be hazardous, or to interfere with, the child's education, or to be harmful to the child's health or physical, mental, spiritual, moral, or social development. Where the relevant labour laws of Kenya have provisions for employment of minors, the Contractor shall follow those laws applicable to the Contractor. Children below the age of 18 years shall not be employed in dangerous work.

6.18 Employment Records of Workers

The Contractor shall keep complete and accurate records of the employment of labour at the Site. The records shall include the names, ages, genders, hours worked and wages paid to all workers. These records shall be summarized on a monthly basis and submitted to the Project Manager. These records shall be included in the details to be submitted by the Contractor under Sub-Clause 6.10 [Records of Contractor's Personnel and Equipment].

6.19 Workers' Organizations

The Contractor shall comply with the relevant labour laws that recognize workers' rights to form and to join workers' organizations of their choosing without interference.

6.20 Non-Discrimination and Equal Opportunity

The Contractor shall base the labour employment on the principle of equal opportunity and fair treatment, and shall not discriminate with respect to aspects of the employment relationship, including recruitment and hiring, compensation (including wages and benefits), working conditions and terms of employment, access to training, promotion, termination of employment or retirement, and discipline.

7 Plant, Materials and Workmanship

7.1 Manner of Execution

The Contractor shall carry out the manufacture of Plant, the production and manufacture of Materials, and all other execution of the Works:

- a) In the manner (if any) specified in the Contract,
- b) In a proper workmanlike and careful manner, in accordance with recognized good practice, and
- c) with properly equipped facilities and non-hazardous Materials, except as otherwise specified in the Contract.

7.2 Samples

The Contractor shall submit the following samples of Materials, and relevant information, to the Project Manager for consent prior to using the Materials in or for the Works:

- a) manufacturer's standard samples of Materials and samples specified in the Contract, all at the Contractor's cost, and
- b) additional samples instructed by the Project Manager as a Variation.

Each sample shall be labelled as to origin and intended use in the Works.

7.3 Inspection

7.3.1 The Procuring Entity's Personnel shall at all reasonable times:

- a) Have full access to all parts of the Site and to all places from which natural Materials are being obtained, and
- b) during production, manufacture and construction (at the Site and elsewhere), be entitled to examine, inspect, measure and test the materials and workmanship, and to check the progress of manufacture of Plant and production and manufacture of Materials.

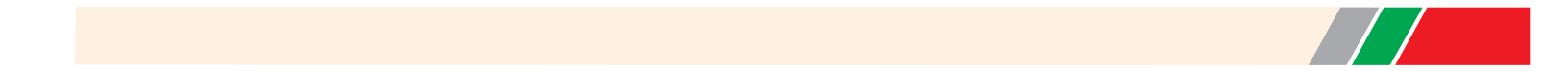

7.3.2 The Contractor shall give the Procuring Entity's Personnel full opportunity to carry out these activities, including providing access, facilities, permissions and safety equipment. No such activity shall relieve the Contractor from any obligation or responsibility.

- 7.3.3 The Contractor shall give notice to the Project Manager whenever any work is ready and before it is covered up, put out of sight, or packaged for storage or transport. The Project Manager shall then either carry out the examination, inspection, measurement or testing without unreasonable delay, or promptly give notice to the Contractor that the Project Manager does not require to do so. If the Contractor fails to give the notice, he shall, if and when required by the Project Manager, uncover the work and thereafter reinstate and make good, all at the Contractor's cost.

7.4 Testing

- 7.4.1 This Sub-Clause shall apply to all tests specified in the Contract, other than the Tests after Completion (if any).
- 7.4.2 Except as otherwise specified in the Contract, the Contractor shall provide all apparatus, assistance, documents and other information, electricity, equipment, fuel, consumables, instruments, labor, materials, and suitably qualified and experienced staff, as are necessary to carry out the specified tests efficiently. The Contractor shall agree, with the Project Manager, the time and place for the specified testing of any Plant, Materials and other parts of the Works.
- 7.4.3 The Project Manager may, under Clause 13 [Variations and Adjustments], vary the location or details of specified tests, or instruct the Contractor to carry out additional tests. If these varied or additional tests show that the tested Plant, Materials or workmanship is not in accordance with the Contract, the cost of carrying out this Variation shall be borne by the Contractor, notwithstanding other provisions of the Contract.
- 7.4.4 The Project Manager shall give the Contractor not less than 24hours' notice of the Project Manager's intention to attend the tests. If the Project Manager does not attend at the time and place agreed, the Contractor may proceed with the tests, unless otherwise instructed by the Project Manager, and the tests shall then be deemed to have been made in the Project Manager's presence.
- 7.4.5 If the Contractor suffers delay and/ or incurs Cost from complying with these instructions or as a result of a delay for which the Procuring Entity is responsible, the Contractor shall give notice to the Project Manager and shall be entitled subject to Sub-Clause 20.1 [Contractor's Claims] to:
- a) an extension of time for any such delay, if completion is or will be delayed, under Sub-Clause 8.4 [Extension of Time for Completion], and
 - b) payment of any such Cost-plus profit, which shall be included in the Contract Price.
- 7.4.6 After receiving this notice, the Project Manager shall proceed in accordance with Sub-Clause 3.5 [Determinations] to agree or determine these matters.
- 7.4.7 The Contractor shall promptly forward to the Project Manager duly certified reports of the tests. When the specified tests have been passed, the Project Manager shall endorse the Contractor's test certificate, or issue a certificate to him, to that effect. If the Project Manager has not attended the tests, he shall be deemed to have accepted the readings as accurate.

7.5 Rejection

- 7.5.1 If, as a result of an examination, inspection, measurement or testing, any Plant, Materials or workmanship is found to be defective or otherwise not in accordance with the Contract, the Project Manager may reject the Plant, Materials or workmanship by giving notice to the Contractor, with reasons. The Contractor shall then promptly make good the defect and ensure that the rejected item complies with the Contract.
- 7.5.2 If the Project Manager requires this Plant, Materials or workmanship to be retested, the tests shall be repeated under the same terms and conditions. If the rejection and retesting cause the Procuring Entity to incur additional costs, the Contractor shall subject to Sub-Clause 2.5 [Procuring Entity's Claims] pay these costs to the Procuring Entity.

7.6 Remedial Work

- 7.6.1 Notwithstanding any previous test or certification, the Project Manager may instruct the Contractor to:

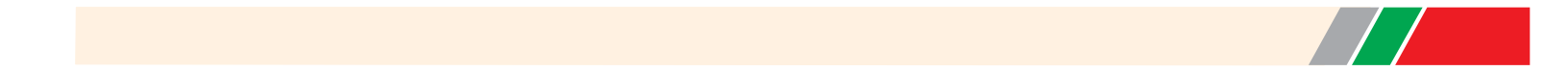
- 
- a) Remove from the Site and replace any Plant or Materials which is not in accordance with the Contract,
 - b) remove and re-execute any other work which is not in accordance with the Contract, and

- c) execute any work which is urgently required for the safety of the Works, whether because of an accident, unforeseeable event or otherwise.

7.6.2 The Contractor shall comply with the instruction within a reasonable time, which shall be the time (if any) specified in the instruction, or immediately if urgency is specified under sub-paragraph(c).

7.6.3 If the Contractor fails to comply with the instruction, the Procuring Entity shall be entitled to employ and pay other persons to carry out the work. Except to the extent that the Contractor would have been entitled to payment for the work, the Contractor shall subject to Sub-Clause 2.5 [Procuring Entity's Claims] pay to the Procuring Entity all costs arising from this failure.

7.7 Ownership of Plant and Materials

7.7.1 Except as otherwise provided in the Contract, each item of Plant and Materials shall become the property of the Procuring Entity at whichever is the earlier of the following times, free from liens and other encumbrances:

- a) When it is incorporated in the Works;
- b) when the Contractor is paid the corresponding value of the Plant and Materials under Sub-Clause 8.10 [Payment for Plant and Materials in Event of Suspension].

7.8 Royalties

Unless otherwise stated in the Specification, the Contractor shall pay all royalties, rents and other payments for:

- a) Natural Materials obtained from outside the Site, and
- b) The disposal of material from demolitions and excavations and of other surplus material (whether natural or man-made), except to the extent that disposal are as within the Site are specified in the Contract.

8 Commencement, Delays and Suspension

8.1 Commencement of Works

8.1.1 Except as otherwise specified in the Particular Conditions of Contract, the Commencement Date shall be the date at which the following precedent conditions have all been fulfilled and the Project Manager's notification recording the agreement of both Parties on such fulfilment and instructing to commence the Work is received by the Contractor:

- a. Signature of the Contract Agreement by both Parties, and if required, approval of the Contract by relevant authorities of Kenya;
- b. Delivery to the Contractor of reasonable evidence of the Procuring Entity's financial arrangements (under Sub-Clause 2.4 [Procuring Entity's Financial Arrangements]);
- c. Except if otherwise specified in the Particular Conditions of Contract, effective access to and possession of the Site given to the Contractor together with such permission(s) under (a) of Sub-Clause 1.13 [Compliance with Laws] as required for the commencement of the Works
- d. Receipt by the Contractor of the Advance Payment under Sub-Clause 14.2 [Advance Payment] provided that the corresponding bank guarantee has been delivered by the Contractor.

8.1.2 If the said Project Manager's instruction is not received by the Contractor within 180 days from his receipt of the Letter of Acceptance, the Contractor shall be entitled to terminate the Contract under Sub-Clause 16.2 [Termination by Contractor].

8.1.3 The Contractor shall commence the execution of the Works as soon as is reasonably practicable after the Commencement Date, and shall then proceed with the Works with due expedition and without delay.

8.2 Time for Completion

The Contractor shall complete the whole of the Works, and each Section (if any), within the Time for



Completion for the Works or Section (as the case may be), including:

- a) Achieving the passing of the Tests on Completion, and

- b) completing all work which is stated in the Contract as being required for the Works or Section to be considered to be completed for the purposes of taking-over under Sub-Clause 10.1 [Taking Over of the Works and Sections].

8.3 Programme

8.3.1 The Contractor shall submit a detailed time programme to the Project Manager within 28 days after receiving the notice under Sub-Clause 8.1 [Commencement of Works]. The Contractor shall also submit a revised programme whenever the previous programme is inconsistent with actual progress or with the Contractor's obligations. Each programme shall include:

- a. The order in which the Contractor intends to carry out the Works, including the anticipated timing of each stage of design (if any), Contractor's Documents, procurement, manufacture of Plant, delivery to Site, construction, erection and testing,
- b. each of these stages for work by each nominated Subcontractor (as defined in Clause 5 [Nominated Subcontractors]),
- c. the sequence and timing of inspections and tests specified in the Contract, and
- d. a supporting report which includes:
 - i. a general description of the methods which the Contractor intends to adopt, and of the major stages, in the execution of the Works, and
 - ii. details showing the Contractor's reasonable estimate of the number of each class of Contractor's Personnel and of each type of Contractor's Equipment, required on the Site for each major stage.

8.3.2 Unless the Project Manager, within 21 days after receiving a programme, gives notice to the Contractor stating the extent to which it does not comply with the Contract, the Contractor shall proceed in accordance with the programme, subject to his other obligations under the Contract. The Procuring Entity's Personnel shall be entitled to rely upon the programme when planning their activities.

8.3.3 The Contractor shall promptly give notice to the Project Manager of specific probable future events or circumstances which may adversely affect the work, increase the Contract Price or delay the execution of the Works. The Project Manager may require the Contractor to submit an estimate of the anticipated effect of the future event or circumstances, and/ or a proposal under Sub-Clause 13.3 [Variation Procedure].

8.3.4 If, at any time, the Project Manager gives notice to the Contractor that a programme fails (to the extent stated) to comply with the Contract or to be consistent with actual progress and the Contractor's stated intentions, the Contractor shall submit a revised programme to the Project Manager in accordance with this Sub-Clause.

8.4 Extension of Time for Completion

8.4.1 The Contractor shall be entitled subject to Sub-Clause 20.1 [Contractor's Claims] to an extension of the Time for Completion if and to the extent that completion for the purposes of Sub-Clause 10.1 [Taking Over of the Works and Sections] is or will be delayed by any of the following causes:

- a. a Variation (unless an adjustment to the Time for Completion has been agreed under Sub-Clause 13.3 [Variation Procedure]) or other substantial change in the quantity of an item of work included in the Contract,
- b. a cause of delay giving an entitlement to extension of time under a Sub-Clause of these Conditions,
- c. exceptionally adverse climatic conditions,
- d. Unforeseeable shortages in the availability of personnel or Goods caused by epidemic or governmental actions, or
- e. any delay, impediment or prevention caused by or attributable to the Procuring Entity, the Procuring Entity's Personnel, or the Procuring Entity's other contractors.

8.4.2 If the Contractor considers himself to be entitled to an extension of the Time for Completion, the Contractor shall give notice to the Project Manager in accordance with Sub-Clause 20.1 [Contractor's Claims]. When determining each extension of time under Sub-Clause 20.1, the Project Manager shall

review previous determinations and may increase, but shall not decrease, the total extension of time.

8.5 Delays Caused by Authorities

If the following conditions apply, namely:

- a) The Contractor has diligently followed the procedures laid down by the relevant legally constituted public authorities in Kenya,
- b) These authorities delay or disrupt the Contractor's work, and
- c) The delay or disruption was Unforeseeable, then this delay or disruption will be considered as a cause of delay under sub-paragraph (b) of Sub-Clause 8.4 [Extension of Time for Completion].

8.6 Rate of Progress

8.6.1 If, at any time:

- a. Actual progress is too slow to complete within the Time for Completion, and/or
- b. Progress has fallen (or will fall) behind the current programme under Sub-Clause 8.3 [Programme], other than as a result of a cause listed in Sub-Clause 8.4 [Extension of Time for Completion], then the Project Manager may instruct the Contractor to submit, under Sub-Clause 8.3 [Programme], a revised programme and supporting report describing the revised methods which the Contractor proposes to adopt in order to expedite progress and complete within the Time for Completion.

8.6.2 Unless the Project Manager notifies otherwise, the Contractor shall adopt these revised methods, which may require increases in the working hours and/or in the numbers of Contractor's Personnel and/or Goods, at the risk and cost of the Contractor. If these revised methods cause the Procuring Entity to incur additional costs, the Contractor shall subject to notice under Sub-Clause 2.5 [Procuring Entity's Claims] pay these costs to the Procuring Entity, in addition to delay damages (if any) under Sub-Clause 8.7 below.

8.6.3 Additional costs of revised methods including acceleration measures, instructed by the Project Manager to reduce delays resulting from causes listed under Sub-Clause 8.4 [Extension of Time for Completion] shall be paid by the Procuring Entity, without generating, however, any other additional payment benefit to the Contractor.

8.7 Delay Damages

8.7.1 If the Contractor fails to comply with Sub-Clause 8.2 [Time for Completion], the Contractor shall subject to notice under Sub-Clause 2.5 [Procuring Entity's Claims] pay delay damages to the Procuring Entity for this default. These delay damages shall be the sum stated in the **Particular Conditions of Contract**, which shall be paid for every day which shall elapse between the relevant Time for Completion and the date stated in the Taking-Over Certificate. However, the total amount due under this Sub-Clause shall not exceed the maximum amount of delay damages (if any) stated in the Particular Conditions of Contract.

8.7.2 These delay damages shall be the only damages due from the Contractor for such default, other than in the event of termination under Sub-Clause 15.2 [Termination by Procuring Entity] prior to completion of the Works. These damages shall not relieve the Contractor from his obligation to complete the Works, or from any other duties, obligations or responsibilities which he may have under the Contract.

8.8 Suspension of Work

8.8.1 The Project Manager may at any time instruct the Contractor to suspend progress of part or all of the Works. During such suspension, the Contractor shall protect, store and secure such part or the Works against any deterioration, loss or damage.

8.8.2 The Project Manager may also notify the cause for the suspension. If and to the extent that the cause is notified and is the responsibility of the Contractor, the following Sub-Clauses 8.9, 8.10 and 8.11 shall not apply.

8.9 Consequences of Suspension

8.9.1 If the Contractor suffers delay and/or incurs Cost from complying with the Project Manager's instructions under Sub-Clause 8.8 [Suspension of Work] and/or from resuming the work, the Contractor shall give notice to the Project Manager and shall be entitled subject to Sub-Clause 20.1 [Contractor's Claims] to:

- a. an extension of time for any such delay, if completion is or will be delayed, under Sub-Clause 8.4 [Extension of Time for Completion], and
 - b. payment of any such Cost, which shall be included in the Contract Price.
- 8.9.2 After receiving this notice, the Project Manager shall proceed in accordance with Sub-Clause 3.5 [Determinations] to agree or determine these matters.
- 8.9.3 The Contractor shall not be entitled to an extension of time for, or to payment of the Cost incurred in, making good the consequences of the Contractor's faulty design, workmanship or materials, or of the Contractor's failure to protect, store or secure in accordance with Sub-Clause 8.8 [Suspension of Work].

8.10 Payment for Plant and Materials in Event of Suspension

The Contractor shall be entitled to payment of the value (as at the date of suspension) of Plant and/or Materials which have not been delivered to Site, if:

- a) The work on Plant or delivery of Plant and/or Materials has been suspended for more than 28 days, and
- b) the Contractor has marked the Plant and/or Materials as the Procuring Entity's property in accordance with the Project Manager's instructions.

8.11 Prolonged Suspension

If the suspension under Sub-Clause 8.8 [Suspension of Work] has continued for more than 84 days, the Contractor may request the Project Manager's permission to proceed. If the Project Manager does not give permission within 28 days after being requested to do so, the Contractor may, by giving notice to the Project Manager, treat the suspension as an omission under Clause 13 [Variations and Adjustments] of the affected part of the Works. If the suspension affects the whole of the Works, the Contractor may give notice of termination under Sub-Clause 16.2 [Termination by Contractor].

8.12 Resumption of Work

After the permission or instruction to proceed is given, the Contractor and the Project Manager shall jointly examine the Works and the Plant and Materials affected by the suspension. The Contractor shall make good any deterioration or defect in or loss of the Works or Plant or Materials, which has occurred during the suspension after receiving from the Project Manager an instruction to this effect under Clause 13 [Variations and Adjustments].

9 Tests on Completion

9.1 Contractor's Obligations

- 9.1.1 The Contractor shall carry out the Tests on Completion in accordance with this Clause and Sub-Clause 7.4 [Testing], after providing the documents in accordance with sub-paragraph (d) of Sub-Clause 4.1 [Contractor's General Obligations].
- 9.1.2 The Contractor shall give to the Project Manager not less than 21 days' notice of the date after which the Contractor will be ready to carry out each of the Tests on Completion. Unless otherwise agreed, Tests on Completion shall be carried out within 14 days after this date, on such day or days as the Project Manager shall instruct.
- 9.1.3 In considering the results of the Tests on Completion, the Project Manager shall make allowances for the effect of any use of the Works by the Procuring Entity on the performance or other characteristics of the Works. As soon as the Works, or a Section, have passed any Tests on Completion, the Contractor shall submit a certified report of the results of these Tests to the Project Manager.

9.2 Delayed Tests

- 9.2.1 If the Tests on Completion are being unduly delayed by the Procuring Entity, Sub-Clause 7.4 [Testing] (fifth paragraph) and/or Sub-Clause 10.3 [Interference with Tests on Completion] shall be applicable.

9.2.2 If the Tests on Completion are being unduly delayed by the Contractor, the Project Manager may by notice require the Contractor to carry out the Tests within 21 days after receiving the notice. The Contractor shall carry out the Tests on such day or days within that period as the Contractor may fix and of which he shall give notice to the Project Manager.

9.2.3 If the Contractor fails to carry out the Tests on Completion within the period of 21 days, the Procuring Entity's Personnel may proceed with the Tests at the risk and cost of the Contractor. The Tests on Completion shall then be deemed to have been carried out in the presence of the Contractor and the results of the Tests shall be accepted as accurate.

9.3 Retesting

If the Works, or a Section, fail to pass the Tests on Completion, Sub-Clause 7.5 [Rejection] shall apply, and the Project Manager or the Contractor may require the failed Tests, and Tests on Completion on any related work, to be repeated under the same terms and conditions.

9.4 Failure to Pass Tests on Completion

9.4.1 If the Works, or a Section, fail to pass the Tests on Completion repeated under Sub-Clause 9.3 [Retesting], the Project Manager shall be entitled to:

- a. Order further repetition of Tests on Completion under Sub-Clause 9.3;
- b. if the failure deprives the Procuring Entity of substantially the whole benefit of the Works or Section, reject the Works or Section (as the case may be), in which event the Procuring Entity shall have the same remedies as are provided in sub-paragraph (c) of Sub-Clause 11.4 [Failure to Remedy Defects]; or
- c. issue a Taking-Over Certificate, if the Procuring Entity so requests.

9.4.2 In the event of sub-paragraph (c), the Contractor shall proceed in accordance with all other obligations under the Contract, and the Contract Price shall be reduced by such amount as shall be appropriate to cover the reduced value to the Procuring Entity as a result of this failure. Unless the relevant reduction for this failure is stated (or its method of calculation is defined) in the Contract, the Procuring Entity may require the reduction to be (i) agreed by both Parties (in full satisfaction of this failure only) and paid before this Taking-Over Certificate is issued, or (ii) determined and paid under Sub-Clause 2.5 [Procuring Entity's Claims] and Sub-Clause 3.5 [Determinations].

10 Procuring Entity's Taking Over

10.1 Taking Over of the Works and Sections

10.1.1 Except as stated in Sub-Clause 9.4 [Failure to Pass Tests on Completion], the Works shall be taken over by the Procuring Entity when (i) the Works have been completed in accordance with the Contract, including the matters described in Sub-Clause 8.2 [Time for Completion] and except as allowed in sub-paragraph (a) below, and (ii) a Taking-Over Certificate for the Works has been issued, or is deemed to have been issued in accordance with this Sub-Clause.

10.1.2 The Contractor may apply by notice to the Project Manager for a Taking-Over Certificate not earlier than 14 days before the Works will, in the Contractor's opinion, be complete and ready for taking over. If the Works are divided into Sections, the Contractor may similarly apply for a Taking-Over Certificate for each Section.

10.1.3 The Project Manager shall, within 28 days after receiving the Contractor's application:

- a. Issue the Taking-Over Certificate to the Contractor, stating the date on which the Works or Section were completed in accordance with the Contract, except for any minor outstanding work and defects which will not substantially affect the use of the Works or Section for their intended purpose (either until or whilst this work is completed and these defects are remedied); or
- b. reject the application, giving reasons and specifying the work required to be done by the Contractor to enable the Taking-Over Certificate to be issued. The Contractor shall then complete this work before issuing a further notice under this Sub-Clause.

10.1.4 If the Project Manager fails either to issue the Taking-Over Certificate or to reject the Contractor's

application within the period of 28 days, and if the Works or Section (as the case may be) are substantially in accordance with the Contract, the Taking-Over Certificate shall be deemed to have been issued on the last day of that period.

10.2 Taking Over of Parts of the Works

- 10.2.1 The Project Manager may, at the sole discretion of the Procuring Entity, issue a Taking-Over Certificate for any part of the Permanent Works.
- 10.2.2 The Procuring Entity shall not use any part of the Works (other than as a temporary measure which is either specified in the Contract or agreed by both Parties) unless and until the Project Manager has issued a Taking- Over Certificate for this part. However, if the Procuring Entity does use any part of the Works before the Taking- Over Certificate is issued:
- a) The part which is used shall be deemed to have been taken over as from the date on which it is used,
 - b) The Contractor shall cease to be liable for the care of such part as from this date, when responsibility shall pass to the Procuring Entity, and
 - c) If requested by the Contractor, the Project Manager shall issue a Taking-Over Certificate for this part.
- 10.2.3 After the Project Manager has issued a Taking-Over Certificate for a part of the Works, the Contractor shall be given the earliest opportunity to take such steps as may be necessary to carry out any outstanding Tests on Completion. The Contractor shall carry out these Tests on Completion as soon as practicable before the expiry date of the relevant Defects Notification Period.
- 10.2.4 If the Contractor incurs Cost as a result of the Procuring Entity taking over and/or using a part of the Works, other than such use as is specified in the Contractor agreed by the Contractor, the Contractor shall (i) give notice to the Project Manager and (ii) be entitled subject to Sub-Clause 20.1 [Contractor's Claims] to payment of any such Cost-plus profit, which shall be included in the Contract Price. After receiving this notice, the Project Manager shall proceed in accordance with Sub-Clause 3.5 [Determinations] to agree or determine this Cost and profit.
- 10.2.5 If a Taking-Over Certificate has been issued for a part of the Works (other than a Section), the delay damages thereafter for completion of the remainder of the Works shall be reduced. Similarly, the delay damages for the remainder of the Section (if any) in which this part is included shall also be reduced. For any period of delay after the date stated in this Taking-Over Certificate, the proportional reduction in these delay damages shall be calculated as the proportion which the value of the part so certified bears to the value of the Works or Section (as the case may be) as a whole. The Project Manager shall proceed in accordance with Sub-Clause 3.5 [Determinations] to agree or determine these proportions. The provisions of this paragraph shall only apply to the daily rate of delay damages under Sub-Clause 8.7 [Delay Damages], and shall not affect the maximum amount of these damages.

10.3 Interference with Tests on Completion

- 10.3.1 If the Contractor is prevented, for more than 14 days, from carrying out the Tests on Completion by a cause for which the Procuring Entity is responsible, the Procuring Entity shall be deemed to have taken over the Works or Section (as the case may be) on the date when the Tests on Completion would otherwise have been completed.
- 10.3.2 The Project Manager shall then issue a Taking-Over Certificate accordingly, and the Contractor shall carry out the Tests on Completion as soon as practicable, before the expiry date of the Defects Notification Period. The Project Manager shall require the Tests on Completion to be carried out by giving 14 days' notice and in accordance with the relevant provisions of the Contract.
- 10.3.3 If the Contractor suffers delay and/or incurs Cost as a result of this delay in carrying out the Tests on Completion, the Contractor shall give notice to the Project Manager and shall be entitled subject to Sub-Clause 20.1 [Contractor's Claims] to:
- a an extension of time for any such delay, if completion is or will be delayed, under Sub-Clause 8.4 [Extension of Time for Completion], and
 - b payment of any such Cost-plus profit, which shall be included in the Contract Price.
- 10.3.4 After receiving this notice, the Project Manager shall proceed in accordance with Sub-Clause 3.5 [Determinations] to agree or determine these matters.

10.4 Surfaces Requiring Reinstatement

Except as otherwise stated in a Taking-Over Certificate, a certificate for a Section or part of the Works shall not be deemed to certify completion of any ground or other surfaces requiring reinstatement.

11. Defects Liability

11.1.1 Completion of Outstanding Work and Remedying Defects

11.1.2 In order that the Works and Contractor's Documents, and each Section, shall be in the condition required by the Contract (fair wear and tear excepted) by the expiry date of the relevant Defects Notification Period or as soon as practicable thereafter, the Contractor shall:

- a) complete any work which is outstanding on the date stated in a Taking-Over Certificate, within such reasonable time as is instructed by the Project Manager, and
- b) execute all work required to remedy defects or damage, as may be notified by (or on behalf of) the Procuring Entity on or before the expiry date of the Defects Notification Period for the Works or Section (as the case may be).

11.1.3 If a defect appears or damage occurs, the Contractor shall be notified accordingly, by (or on behalf of) the Procuring Entity.

11.2 Cost of Remedying Defects

11.2.1 All work referred to in sub-paragraph (b) of Sub-Clause 11.1 [Completion of Outstanding Work and Remedying Defects] shall be executed at the risk and cost of the Contractor, if and to the extent that the work is attributable to:

- a) Any design for which the Contractor is responsible,
- b) Plant, Materials or workmanship not being in accordance with the Contract, or
- c) Failure by the Contractor to comply with any other obligation.

11.2.2 If and to the extent that such work is attributable to any other cause, the Contractor shall be notified promptly by (or on behalf of) the Procuring Entity, and Sub-Clause 13.3 [Variation Procedure] shall apply.

11.3 Extension of Defects Notification Period

11.3.1 The Procuring Entity shall be entitled subject to Sub-Clause 2.5 [Procuring Entity's Claims] to an extension of the Defects Notification Period for the Works or a Section if and to the extent that the Works, Section or a major item of Plant (as the case may be, and after taking over) cannot be used for the purposes for which they are intended by reason of a defect or by reason of damage attributable to the Contractor. However, a Defects Notification Period shall not be extended by more than two years.

11.3.2 If delivery and/or erection of Plant and/or Materials was suspended under Sub-Clause 8.8 [Suspension of Work] or Sub-Clause 16.1 [Contractor's Entitlement to Suspend Work], the Contractor's obligations under this Clause shall not apply to any defects or damage occurring more than two years after the Defects Notification Period for the Plant and/or Materials would otherwise have expired.

11.4 Failure to Remedy Defects

11.4.1 If the Contractor fails to remedy any defect or damage within a reasonable time, a date may be fixed by (or on behalf of) the Procuring Entity, on or by which the defect or damage is to be remedied. The Contractor shall be given reasonable notice of this date.

11.4.2 If the Contractor fails to remedy the defect or damage by this notified date and this remedial work was to be executed at the cost of the Contractor under Sub-Clause 11.2 [Cost of Remedying Defects], the Procuring Entity may (at his option):

- a. carry out the work himself or by others, in a reasonable manner and at the Contractor's cost, but the Contractor shall have no responsibility for this work; and the Contractor shall subject to Sub-Clause 2.5 [Procuring Entity's Claims] pay to the Procuring Entity the costs reasonably incurred by the Procuring Entity in remedying the defect or damage;
- b. require the Project Manager to agree or determine a reasonable reduction in the Contract Price in accordance

with Sub-Clause 3.5 [Determinations]; or

- c. if the defect or damage deprives the Procuring Entity of substantially the whole benefit of the Works or any major part of the Works, terminate the Contract as a whole, or in respect of such major part which cannot be put to the intended use. Without prejudice to any other rights, under the Contract otherwise, the Procuring Entity shall then be entitled to recover all sums paid for the Works or for such part (as the case may be), plus financing costs and the cost of dismantling the same, clearing the Site and returning Plant and Materials to the Contractor.

11.5 Removal of Defective Work

If the defect or damage cannot be remedied expeditiously on the Site and the Procuring Entity gives consent, the Contractor may remove from the Site for the purposes of repair such items of Plant as are defective or damaged. This consent may require the Contractor to increase the amount of the Performance Security by the full replacement cost of these items, or to provide other appropriate security.

11.6 Further Tests

- 11.6.1 If the work of remedying of any defect or damage may affect the performance of the Works, the Project Manager may require the repetition of any of the tests described in the Contract. The requirement shall be made by notice within 28 days after the defect or damage is remedied.
- 11.6.2 These tests shall be carried out in accordance with the terms applicable to the previous tests, except that they shall be carried out at the risk and cost of the Party liable, under Sub-Clause 11.2 [Cost of Remedying Defects], for the cost of the remedial work.

11.7 Right of Access

Until the Performance Certificate has been issued, the Contractor shall have such right of access to the Works as is reasonably required in order to comply with this Clause, except as may be inconsistent with the Procuring Entity's reasonable security restrictions.

11.8 Contractor to Search

The Contractor shall, if required by the Project Manager, search for the cause of any defect, under the direction of the Project Manager. Unless the defect is to be remedied at the cost of the Contractor under Sub-Clause 11.2 [Cost of Remedying Defects], the Cost of the search plus profit shall be agreed or determined by the Project Manager in accordance with Sub-Clause 3.5 [Determinations] and shall be included in the Contract Price.

11.9 Performance Certificate

- 11.9.1 Performance of the Contractor's obligations shall not be considered to have been completed until the Project Manager has issued the Performance Certificate to the Contractor, stating the date on which the Contractor completed his obligations under the Contract.
- 11.9.2 The Project Manager shall issue the Performance Certificate within 28 days after the latest of the expiry dates of the Defects Notification Periods, or as soon thereafter as the Contractor has supplied all the Contractor's Documents and completed and tested all the Works, including remedying any defects. A copy of the Performance Certificate shall be issued to the Procuring Entity.
- 11.9.3 Only the Performance Certificate shall be deemed to constitute acceptance of the Works.

11.10 Unfulfilled Obligations

After the Performance Certificate has been issued, each Party shall remain liable for the fulfilment of any obligation which remains unperformed at that time. For the purposes of determining the nature and extent of unperformed obligations, the Contract shall be deemed to remain in force.

11.11 Clearance of Site

- 11.11.1 Upon receiving the Performance Certificate, the Contractor shall remove any remaining Contractor's Equipment, surplus material, wreckage, rubbish and Temporary Works from the Site.
- 11.11.2 If all these items have not been removed within 28 days after receipt by the Contractor of the Performance Certificate, the Procuring Entity may sell or otherwise dispose of any remaining items. The Procuring Entity shall be entitled to be paid the costs incurred in connection with, or attributable to, such sale or disposal and restoring

the Site.

- 11.11.3 Any balance of the moneys from the sale shall be paid to the Contractor. If these moneys are less than the Procuring Entity's costs, the Contractor shall pay the outstanding balance to the Procuring Entity.

12 Measurement and Evaluation

12.1 Works to be Measured

- 12.1.1 The Works shall be measured, and valued for payment, in accordance with this Clause. The Contractor shall show in each application under Sub-Clauses 14.3 [Application for Interim Payment Certificates], 14.10 [Statement on Completion] and 14.11 [Application for Final Payment Certificate] the quantities and other particulars detailing the amounts which he considers to be entitled under the Contract.
- 12.1.2 Whenever the Project Manager requires any part of the Works to be measured, reasonable notice shall be given to the Contractor's Representative, who shall:
- a. Promptly either attend or send another qualified representative to assist the Project Manager in making the measurement, and
 - b. Supply any particulars requested by the Project Manager.
- 12.1.3 If the Contractor fails to attend or send a representative, the measurement made by (or on behalf of) the Project Manager shall be accepted as accurate.
- 12.1.4 Except as otherwise stated in the Contract, wherever any Permanent Works are to be measured from records, these shall be prepared by the Project Manager. The Contractor shall, as and when requested, attend to examine and agree the records with the Project Manager, and shall sign the same when agreed. If the Contractor does not attend, the records shall be accepted as accurate.
- 12.1.5 If the Contractor examines and disagrees with the records, and/or does not sign them as agreed, then the Contractor shall give notice to the Project Manager of the respects in which the records are asserted to be inaccurate. After receiving this notice, the Project Manager shall review the records and either confirm or vary them and certify the payment of the undisputed part. If the Contractor does not so give notice to the Project Manager within 14 days after being requested to examine the records, they shall be accepted as accurate.

12.2 Method of Measurement

Except as otherwise stated in the Contract and not withstanding local practice:

- a) Measurement shall be made of the net actual quantity of each item of the Permanent Works, and
- b) the method of measurement shall be in accordance with the Bill of Quantities or other applicable Schedules.

12.3 Evaluation

- 12.3.1 Except as otherwise stated in the Contract, the Project Manager shall proceed in accordance with Sub-Clause 3.5 [Determinations] to agree or determine the Contract Price by evaluating each item of work, applying the measurement agreed or determined in accordance with the above Sub-Clauses 12.1 and 12.2 and the appropriate rate or price for the item.
- 12.3.2 For each item of work, the appropriate rate or price for the item shall be the rate or price specified for such item in the Contractor, if there is no such item, specified for similar work.
- 12.3.3 Any item of work included in the Bill of Quantities for which no rate or price was specified shall be considered as included in other rates and prices in the Bill of Quantities and will not be paid for separately.
- 12.3.4 However, a new rate or price shall be appropriate for an item of work if:
- a)
 - i) the measured quantity of the item is changed by more than 25% from the quantity of this item in the Bill of Quantities or another Schedule,
 - ii) this change in quantity multiplied by such specified rate for this item exceeds 0.25% of the Accepted Contract Amount,
 - iii) this change in quantity directly changes the Cost per unit quantity of this item by more than 1%, and

- iv) this item is not specified in the Contract as a “fixed rate item”; or
- b) the work is instructed under Clause 13 [Variations and Adjustments],
 - ii) no rate or price is specified in the Contract for this item, and
 - iii) no specified rate or price is appropriate because the item of work is not of similar character, or is not executed under similar conditions, as any item in the Contract.
- b) Each new rate or price shall be derived from any relevant rates or prices in the Contract, with reasonable adjustments to take account of the matters described in sub-paragraph (a) and/or (b), as applicable. If no rates or prices are relevant for the derivation of a new rate or price, it shall be derived from the reasonable Cost of executing the work, together with profit, taking account of any other relevant matters.
- c) Until such time as an appropriate rate or price is agreed or determined, the Project Manager shall determine a provisional rate or price for the purposes of Interim Payment Certificates as soon as the concerned work commences.

12.4 Omissions

- d) Whenever the omission of any work forms part (or all) of a Variation, the value of which has not been agreed, if:
 - i) The Contractor will incur (or has incurred) cost which, if the work had not been omitted, would have been deemed to be covered by a sum forming part of the Accepted Contract Amount;
 - ii) The omission of the work will result (or has resulted) in this sum not forming part of the Contract Price; and
 - iii) This cost is not deemed to be included in the evaluation of any substituted work;
- 12.4.1 then the Contractor shall give notice to the Project Manager accordingly, with supporting particulars. Upon receiving this notice, the Project Manager shall proceed in accordance with Sub-Clause 3.5 [Determinations] to agree or determine this cost, which shall be included in the Contract Price.

13 Variations and Adjustments

13.1 Right to Vary

- 13.1.1 Variations may be initiated by the Project Manager at any time prior to issuing the Taking-Over Certificate for the Works, either by an instruction or by a request for the Contractor to submit a proposal.
- 13.1.2 The Contractor shall execute and be bound by each Variation, unless the Contractor promptly gives notice to the Project Manager stating (with supporting particulars) that (i) the Contractor cannot readily obtain the Goods required for the Variation, or (ii) such Variation triggers a substantial change in the sequence or progress of the Works. Upon receiving this notice, the Project Manager shall cancel, confirm or vary the instruction.
- 13.1.3 Each Variation may include:
 - a. changes to the quantities of any item of work included in the Contract (however, such changes do not necessarily constitute a Variation),
 - b. changes to the quality and other characteristics of any item of work,
 - c. changes to the levels, positions and/or dimensions of any part of the Works,
 - d. omission of any work unless it is to be carried out by others,
 - e. any additional work, Plant, Materials or services necessary for the Permanent Works, including any associated Tests on Completion, bore holes and other testing and exploratory work, or
 - f. changes to the sequence or timing of the execution of the Works.
- 13.1.4 The Contractor shall not make any alteration and/or modification of the Permanent Works, unless and until the Project Manager instructs or approves a Variation.

13.2 Value Project Managering

- 13.2.1 The Contractor may, at any time, submit to the Project Manager a written proposal which (in the Contractor's opinion) will, if adopted, (i) accelerate completion, (ii) reduce the cost to the Procuring Entity of executing, maintaining or operating the Works, (iii) improve the efficiency or value to the Procuring Entity of the completed Works, or (iv) otherwise be of benefit to the Procuring Entity.

- 13.2.2 The proposal shall be prepared at the cost of the Contractor and shall include the items listed in Sub-Clause 13.3 [Variation Procedure].
- 13.2.3 If a proposal, which is approved by the Project Manager, includes a change in the design of part of the Permanent Works, then unless otherwise agreed by both Parties:
- a. The Contractor shall design this part,
 - b. sub-paragraphs (a) to (d) of Sub-Clause 4.1 [Contractor's General Obligations] shall apply, and
 - c. if this change results in a reduction in the contract value of this part, the Project Manager shall proceed in accordance with Sub-Clause 3.5 [Determinations] to agree or determine a fee, which shall be included in the Contract Price. This fee shall be half (50%) of the difference between the following amounts:
 - a. such reduction in contract value, resulting from the change, excluding adjustments under Sub-Clause 13.7 [Adjustments for Changes in Legislation] and Sub-Clause 13.8 [Adjustments for Changes in Cost], and
 - b. the reduction (if any) in the value to the Procuring Entity of the varied works, taking account of any reductions in quality, anticipated life or operational efficiencies.
- 13.2.4 However, if amount (i) is less than amount (ii), there shall not be a fee.

13.3 Variation Procedure

- 13.3.1 If the Project Manager requests a proposal, prior to instructing a Variation, the Contractor shall respond in writing as soon as practicable, either by giving reasons why he cannot comply (if this is the case) or by submitting:
- a. A description of the proposed work to be performed and a programme for its execution,
 - b. The Contractor's proposal for any necessary modifications to the programme according to Sub-Clause 8.3 [Programme] and to the Time for Completion, and
 - c. The Contractor's proposal for evaluation of the Variation.
- 13.3.2 The Project Manager shall, as soon as practicable after receiving such proposal (under Sub-Clause 13.2 [Value Project Managerring] or otherwise), respond with approval, disapproval or comments. The Contractor shall not delay any work whilst awaiting a response.
- 13.3.3 Each instruction to execute a Variation, with any requirements for the recording of Costs, shall be issued by the Project Manager to the Contractor, who shall acknowledge receipt.
- 13.3.4 Each Variation shall be evaluated in accordance with Clause 12 [Measurement and Evaluation], unless the Project Manager instructs or approves otherwise in accordance with this Clause.

13.4 Payment in Applicable Currencies

If the Contract provides for payment of the Contract Price in more than one currency, then whenever an adjustment is agreed, approved or determined as stated above, the amount payable in each of the applicable currencies shall be specified. For this purpose, reference shall be made to the actual or expected currency proportions of the Cost of the varied work, and to the proportions of various currencies specified for payment of the Contract Price.

13.5 Provisional Sums

- 13.5.1 Each Provisional Sum shall only be used, in whole or in part, in accordance with the Project Manager's instructions, and the Contract Price shall be adjusted accordingly. The total sum paid to the Contractor shall include only such amounts, for the work, supplies or services to which the Provisional Sum relates, as the Project Manager shall have instructed. For each Provisional Sum, the Project Manager may instruct:
- a. Work to be executed (including Plant, Materials or services to be supplied) by the Contractor and valued under Sub-Clause 13.3 [Variation Procedure]; and/or
 - b. Plant, Materials or services to be purchased by the Contractor, from a nominated Subcontractor (as defined in Clause 5 [Nominated Subcontractors]) or otherwise; and for which there shall be included in the Contract Price:
 - i. The actual amounts paid (or due to be paid) by the Contractor, and
 - ii. a sum for overhead charges and profit, calculated as a percentage of these actual amounts by applying the relevant percentage rate (if any) stated in the appropriate Schedule. If there is no

such rate, the percentage rate stated in **the Particular Conditions of Contract** shall be applied.

- 13.5.2 The Contractor shall, when required by the Project Manager, produce quotations, invoices, vouchers and accounts or receipts in substantiation.

13.6 Day works

- 13.6.1 For work of a minor or incidental nature, the Project Manager may instruct that a Variation shall be executed on a day work basis. The work shall then be valued in accordance with the Day work Schedule included in the Contract, and the following procedure shall apply. If a Day work Schedule is not included in the Contract, this Sub-Clause shall not apply.

- 13.6.2 Before ordering Goods for the work, the Contractor shall submit quotations to the Project Manager. When applying for payment, the Contractor shall submit invoices, vouchers and accounts or receipts for any Goods.

- 13.6.3 Except for any items for which the Day work Schedule specifies that payment is not due, the Contractor shall deliver each day to the Project Manager accurate statements in duplicate which shall include the following details of the resources used in executing the previous day's work:

- a. The names, occupations and time of Contractor's Personnel,
- b. The identification, type and time of Contractor's Equipment and Temporary Works, and
- c. The quantities and types of Plant and Materials used.

- 13.6.4 One copy of each statement will, if correct, or when agreed, be signed by the Project Manager and returned to the Contractor. The Contractor shall then submit priced statements of these resources to the Project Manager, prior to their inclusion in the next Statement under Sub-Clause 14.3 [Application for Interim Payment Certificates].

13.7 Adjustments for Changes in Legislation

- 13.7.1 The Contract Price shall be adjusted to take account of any increase or decrease in Cost resulting from a change in the Laws of Kenya (including the introduction of new Laws and the repeal or modification of existing Laws) or in the judicial or official governmental interpretation of such Laws, made after the Base Date, which affect the Contractor in the performance of obligations under the Contract.

- 13.7.2 If the Contractor suffers (or will suffer) delay and/or incurs (or will incur) additional Cost as a result of these changes in the Laws or in such interpretations, made after the Base Date, the Contractor shall give notice to the Project Manager and shall be entitled subject to Sub-Clause 20.1 [Contractor's Claims] to:

- a. an extension of time for any such delay, if completion is or will be delayed, under Sub-Clause 8.4 [Extension of Time for Completion], and
- b. payment of any such Cost, which shall be included in the Contract Price.

- 13.7.3 After receiving this notice, the Project Manager shall proceed in accordance with Sub-Clause 3.5 [Determinations] to agree or determine these matters.

- 13.7.4 Notwithstanding the fore going, the Contractor shall not be entitled to an extension of time if the relevant delay has already been considered in the determination of a previous extension of time and such Cost shall not be separately paid if the same shall already have been considered in the indexing of any inputs to the table of adjustment data in accordance with the provisions of Sub-Clause 13.8 [Adjustments for Changes in Cost].

13.8 Adjustments for Changes in Cost

- 13.8.1 In this Sub-Clause, "table of adjustment data" means the completed table of adjustment data for local and foreign currencies included in the Schedules. If there is no such table of adjustment data, this Sub-Clause shall not apply.

- 13.8.2 If this Sub-Clause applies, the amounts payable to the Contractor shall be adjusted for rises or falls in the cost of labor, Goods and other inputs to the Works, by the addition or deduction of the amounts determined by the formulae prescribed in this Sub-Clause. To the extent that full compensation for any rise or fall in Costs is not covered by the provisions of this or other Clauses, the Accepted Contract Amount shall be deemed to have included amounts to cover the contingency of other rises and falls in costs.

- 13.8.3 The adjustment to be applied to the amount otherwise payable to the Contractor, as valued in accordance with the appropriate Schedule and certified in Payment Certificates, shall be determined from formulae for each of the currencies in which the Contract Price is payable. No adjustment is to be applied to work valued on the basis of

Cost or current prices. The formulae shall be of the following general type:

Price Adjustment

Prices shall be adjusted for fluctuations in the cost of inputs only if **provided for in the SCC**. If so provided, the amounts certified in each payment certificate, before deducting for Advance Payment, shall be adjusted by applying the respective price adjustment factor to the payment amounts due in each currency. A separate formula of the type specified below applies:

$$P = A + B \text{ Im/Io}$$

where:

P is

the adjustment factor for the portion of the Contract Price payable.

A and B are coefficients **specified in the SCC**, representing the non-adjustable and adjustable portions, respectively, of the Contract Price payable and Im is the index prevailing at the end of the month being invoiced and Io is the index prevailing 28 days before Tender opening for inputs payable.

NOTE: The sum of the two coefficients A and B should be 1 (one) in the formula for each currency. Normally, both coefficients shall be the same in the formulae for all currencies, since coefficient A, for the non-adjustable portion of the payments, is a very approximate figure (usually 0.15) to take account of fixed cost elements or other non-adjustable components. The sum of the adjustments for each currency are added to the Contract Price.

- 13.8.4 The cost indices or reference prices stated in the table of adjustment data shall be used. If their source is in doubt, it shall be determined by the Project Manager. For this purpose, reference shall be made to the values of the indices at stated dates (quoted in the fourth and fifth columns respectively of the table) for the purposes of clarification of the source; although these dates (and thus these values) may not correspond to the base cost indices.
- 13.8.5 In cases where the “currency of index” is not the relevant currency of payment, each index shall be converted into the relevant currency of payment at the selling rate, established by the Central Bank of Kenya, of this relevant currency on the above date for which the index is required to be applicable.
- 13.8.6 Until such time as each current cost index is available, the Project Manager shall determine a provisional index for the issue of Interim Payment Certificates. When a current cost index is available, the adjustment shall be recalculated accordingly.
- 13.8.7 If the Contractor fails to complete the Works within the Time for Completion, adjustment of prices thereafter shall be made using either (i) each index or price applicable on the date 49 days prior to the expiry of the Time for Completion of the Works, or (ii) the current index or price, whichever is more favorable to the Procuring Entity.
- 13.8.8 The weightings (coefficients) for each of the factors of cost stated in the table(s) of adjustment data shall only be adjusted if they have been rendered unreasonable, unbalanced or inapplicable, as a result of Variations.

14 Contract Price and Payment

14.1 The Contract Price

14.1.1 Unless otherwise stated in the Particular Conditions:

- a. the Contract Price shall be agreed or determined under Sub-Clause 12.3 [Evaluation] and be subject to adjustments in accordance with the Contract;
- b. the Contractor shall pay all taxes, duties and fees required to be paid by him under the Contract, and the Contract Price shall not be adjusted for any of these costs except as stated in Sub-Clause 13.7 [Adjustments for Changes in Legislation];
- c. any quantities which may be set out in the Bill of Quantities or other Schedule are estimated quantities and are not to be taken as the actual and correct quantities:
 - i. of the Works which the Contractor is required to execute, or
 - ii. for the purposes of Clause 12 [Measurement and Evaluation]; and
- d. the Contractor shall submit to the Project Manager, within 28 days after the Commencement Date, a proposed breakdown of each lump sum price in the Schedules. The Project Manager may take account of the breakdown when preparing Payment Certificates, but shall not be bound by it.

14.1.2 Notwithstanding the provisions of subparagraph (b), Contractor's Equipment, including essential spare parts there for, imported by the Contractor for the sole purpose of executing the Contract shall be exempt from the payment of import duties and taxes upon importation.

14.2 Advance Payment

14.2.1 The Procuring Entity may make an advance payment, as an interest-free loan for mobilization and cash flow support, when the Contractor submits a guarantee in accordance with this Sub-Clause. The total advance payment, the number and timing of instalments (if more than one), and the applicable currencies and proportions, shall be as stated in the **Particular Conditions of Contract**.

14.2.2 Unless and until the Procuring Entity receives this guarantee, or if the total advance payment is not stated in the Particular Conditions of Contract, this Sub-Clause shall not apply.

14.2.3 The Project Manager shall deliver to the Procuring Entity and to the Contractor an Interim Payment Certificate for the advance payment or its first instalment after receiving a Statement (under Sub-Clause 14.3 [Application for Interim Payment Certificates]) and after the Procuring Entity receives (i) the Performance Security in accordance with Sub-Clause 4.2 [Performance Security] and (ii) a guarantee in amounts and currencies equal to the advance payment. This guarantee shall be issued by a reputable bank or financial institution selected by the Contractor and shall be in the form annexed to the Particular Conditions or in another form approved by the Procuring Entity.

14.2.4 The Contractor shall ensure that the guarantee is valid and enforceable until the advance payment has been repaid, but its amount shall be progressively reduced by the amount repaid by the Contractor as indicated in the Payment Certificates. If the terms of the guarantee specify its expiry date, and the advance payment has not been repaid by the date 28 days prior to the expiry date, the Contractor shall extend the validity of the guarantee until the advance payment has been repaid.

14.2.5 Unless stated otherwise in the **Particular Conditions of Contract**, the advance payment shall be repaid through percentage deductions from the interim payments determined by the Project Manager in accordance with Sub-Clause 14.6 [Issue of Interim Payment Certificates], as follows:

- a. Deductions shall commence in the next interim Payment Certificate following that in which the total of all certified interim payments (excluding the advance payment and deductions and repayments of retention) exceeds 30 percent (30%) of the Accepted Contract Amount Less Provisional Sums; and
- b. Deductions shall be made at the amortization rate stated in the **Particular Conditions of Contract** of the amount of each Interim Payment Certificate (excluding the advance payment and deductions for its repayments as well as deductions for retention money) in the currencies and proportions of the advance payment until such time as the advance payment has been repaid; provided that the advance payment shall be completely repaid prior to the time when 90 percent (90%) of the Accepted Contract Amount Less Provisional Sums has been certified for payment.

14.2.6 If the advance payment has not been repaid prior to the issue of the Taking-Over Certificate for the Works or prior to termination under Clause 15 [Termination by Procuring Entity], Clause 16 [Suspension and Termination by Contractor] or Clause 19 [Force Majeure] (as the case may be), the whole of the balance then outstanding shall immediately become due and in case of termination under Clause 15 [Termination by Procuring Entity], except for Sub-Clause 15.5 [Procuring Entity's Entitlement to Termination for Convenience], payable by the Contractor to the Procuring Entity.

14.3 Application for Interim Payment Certificates

14.3.1 The Contractor shall submit a Statement in six copies to the Project Manager after the end of each month, in a form approved by the Project Manager, showing in detail the amounts to which the Contractor considers himself to be entitled, together with supporting documents which shall include the report on the progress during this month in accordance with Sub-Clause 4.21 [Progress Reports].

14.3.2 The Statement shall include the following items, as applicable, which shall be expressed in the various currencies in which the Contract Price is payable, in the sequence listed:

- a. the estimated contract value of the Works executed and the Contractor's Documents produced up to the end of the month (including Variations but excluding items described in sub-paragraphs (b) to (g) below);
- b. any amounts to be added and deducted for changes in legislation and changes in cost, in accordance with Sub-Clause 13.7 [Adjustments for Changes in Legislation] and Sub-Clause 13.8 [Adjustments for Changes in Cost];
- c. any amount to be deducted for retention, calculated by applying the percentage of retention stated in the

Particular Conditions of Contract to the total of the above amounts, until the amount so retained by the Procuring Entity reaches the limit of Retention Money (if any) stated in **the Particular Conditions of Contract**;

- d. any amounts to be added for the advance payment and (if more than one instalment) and to be deducted for its repayments in accordance with Sub-Clause 14.2 [Advance Payment];
- e. any amounts to be added and deducted for Plant and Materials in accordance with Sub-Clause 14.5 [Plant and Materials intended for the Works];
- f. any other additions or deductions which may have become due under the Contract or otherwise, including those under Clause 20 [Claims, Disputes and Arbitration]; and
- g. the deduction of amounts certified in all previous Payment Certificates.

14.4 Schedule of Payments

- 14.4.1 The Contract includes a schedule of payments specifying the instalments in which the Contract Price will be paid, unless otherwise stated in this schedule:
 - a. The instalments quoted in this schedule of payments shall be the estimated contract values for the purposes of sub-paragraph (a) of Sub-Clause 14.3 [Application for Interim Payment Certificates];
 - b. Sub-Clause 14.5 [Plant and Materials intended for the Works] shall not apply; and
 - c. If these instalments are not defined by reference to the actual progress achieved in executing the Works, and if actual progress is found to be less or more than that on which this schedule of payments was based, then the Project Manager may proceed in accordance with Sub-Clause 3.5 [Determinations] to agree or determine revised instalments, which shall take account of the extent to which progress is less or more than that on which the instalments were previously based.
- 14.4.2 The Contract include a schedule of payments, attached to this contract as Document _____
- 14.4.3 The Contractor shall submit non-binding estimates of the payments which he expects to become due during each quarterly period. The first estimate shall be submitted within 42 days after the Commencement Date. Revised estimates shall be submitted at quarterly intervals, until the Taking-Over Certificate has been issued for the Works.

14.5 Plant and Materials intended for the Works

- 14.5.1 If this Sub-Clause applies, Interim Payment Certificates shall include, under sub-paragraph (e) of Sub-Clause 14.3, (i) an amount for Plant and Materials which have been sent to the Site for incorporation in the Permanent Works, and (ii) a reduction when the contract value of such Plant and Materials is included as part of the Permanent Works under sub-paragraph (a) of Sub-Clause 14.3 [Application for Interim Payment Certificates].
- 14.5.2 If the lists referred to in sub-paragraphs (b) (i) or (c) (i) below are not included in the Schedules, this Sub-Clause shall not apply.
- 14.5.3 The Project Manager shall determine and certify each addition if the following conditions are satisfied:
 - a. The Contractor has:
 - (i) Kept satisfactory records (including the orders, receipts, Costs and use of Plant and Materials) which are available for inspection, and
 - (ii) submitted a statement of the Cost of acquiring and delivering the Plant and Materials to the Site, supported by satisfactory evidence;and either:
 - b. the relevant Plant and Materials:
 - (i) are those listed in the Schedules for payment when shipped,
 - (ii) have been shipped to Kenya, enroute to the Site, in accordance with the Contract; and
 - (iii) are described in a clean shipped bill of lading or other evidence of shipment, which has been submitted to the Project Manager together with evidence of payment of freight and insurance, any other documents reasonably required, and a bank guarantee in a form and issued by an entity approved by the Procuring Entity in amounts and currencies equal to the amount due under this Sub-Clause: this guarantee may be in a similar form to the form referred to in Sub-Clause 14.2 [Advance Payment] and shall be valid until the Plant and Materials are properly stored on Site and protected against loss, damage or deterioration; or

c. the relevant Plant and Materials:

- (i) are those listed in the Schedules for payment when delivered to the Site, and
- (ii) have been delivered to and are properly stored on the Site, are protected against loss, damage or deterioration, and appear to be in accordance with the Contract.

14.5.4 The additional amount to be certified shall be the equivalent of eighty percent (80%) of the Project Manager's determination of the cost of the Plant and Materials (including delivery to Site), taking account of the documents mentioned in this Sub-Clause and of the contract value of the Plant and Materials.

14.5.6 The currencies for this additional amount shall be the same as those in which payment will become due when the contract value is included under sub-paragraph (a) of Sub-Clause 14.3 [Application for Interim Payment Certificates]. At that time, the Payment Certificate shall include the applicable reduction which shall be equivalent to, and in the same currencies and proportions as, this additional amount for the relevant Plant and Materials.

14.6 Issue of Interim Payment Certificates

14.6.1 No amount will be certified or paid until the Procuring Entity has received and approved the Performance Security. Thereafter, the Project Manager shall, within 28 days after receiving a Statement and supporting documents, deliver to the Procuring Entity and to the Contractor an Interim Payment Certificate which shall state the amount which the Project Manager fairly determines to be due, with all supporting particulars for any reduction or with holding made by the Project Manager on the Statement if any.

14.6.2 However, prior to issuing the Taking-Over Certificate for the Works, the Project Manager shall not be bound to issue an Interim Payment Certificate in an amount which would (after retention and other deductions) be less than the minimum amount of Interim Payment Certificates (if any) stated **in the Particular Conditions of Contract**. In this event, the Project Manager shall give notice to the Contractor accordingly.

14.6.3 An Interim Payment Certificate shall not be withheld for any other reason, although:

- a) if anything supplied or work done by the Contractor is not in accordance with the Contract, the cost of rectification or replacement may be withheld until rectification or replacement has been completed; and/or
- b) if the Contractor was or is failing to perform any work or obligation in accordance with the Contract, and had been so notified by the Project Manager, the value of this work or obligation may be withheld until the work or obligation has been performed.

14.6.4 The Project Manager may in any Payment Certificate make any correction or modification that should properly be made to any previous Payment Certificate. A Payment Certificate shall not be deemed to indicate the Project Manager's acceptance, approval, consent or satisfaction.

14.7 Payment

14.7.1 The Procuring Entity shall pay to the Contractor:

- a) The first instalment of the advance payment within 42 days after issuing the Letter of Acceptance or within 21 days after receiving the documents in accordance with Sub-Clause 4.2 [Performance Security] and Sub-Clause 14.2 [Advance Payment], whichever is later;
- b) the amount certified in each Interim Payment Certificate within 45 days after the Project Manager receives the Statement and supporting documents; and
- c) the amount certified in the Final Payment Certificate within 45 days after the Procuring Entity receives this Payment Certificate; or after determination of any disputed amount shown in the Final Statement in accordance with Sub-Clause 16.2 [Termination by Contractor].

14.7.2 Payment of the amount due in each currency shall be made into the bank account, nominated by the Contractor, in the payment country (for this currency) specified in the Contract.

14.8 Delayed Payment

14.8.1 If the Contractor does not receive payment in accordance with Sub-Clause 14.7 [Payment], the Contractor shall be entitled to receive financing charges (interest) compounded monthly on the amount unpaid during the period of delay. This period shall be deemed to commence on the date for payment specified in Sub-Clause 14.7 [Payment], irrespective (in the case of its sub-paragraph (b) of the date on which any Interim Payment Certificate is issued.

14.8.2 Unless otherwise stated in **the Particular Conditions**, these financing charges shall be calculated at the annual rate of three percentage points above the discount rate of the central bank in Kenya of the currency of payment, or if not available, the interbank offered rate, and shall be paid in such currency.

14.8.3 The Contractor shall be entitled to this payment without formal notice or certification, and without prejudice 14.9 to any other right or remedy.

14.9 Payment of Retention Money

14.9.2 When the Taking-Over Certificate has been issued for the Works, the first half of the Retention Money shall be certified by the Project Manager for payment to the Contractor. If a Taking-Over Certificate is issued for a Section or part of the Works, a proportion of the Retention Money shall be certified and paid. This proportion shall be half (50%) of the proportion calculated by dividing the estimated contract value of the Section or part, by the estimated final Contract Price.

14.9.3 Promptly after the latest of the expiry dates of the Defects Notification Periods, the outstanding balance of the Retention Money shall be certified by the Project Manager for payment to the Contractor. If a Taking-Over Certificate was issued for a Section, a proportion of the second half of the Retention Money shall be certified and paid promptly after the expiry date of the Defects Notification Period for the Section. This proportion shall be half (50%) of the proportion calculated by dividing the estimated contract value of the Section by the estimated final Contract Price.

14.9.4 However, if any work remains to be executed under Clause 11 [Defects Liability], the Project Manager shall be entitled to withhold certification of the estimated cost of this work until it has been executed.

14.9.5 When calculating these proportions, no account shall be taken of any adjustments under Sub-Clause 13.7 [Adjustments for Changes in Legislation] and Sub-Clause 13.8 [Adjustments for Changes in Cost].

14.9.6 Unless otherwise stated in the Particular Conditions, when the Taking-Over Certificate has been issued for the Works and the first half of the Retention Money has been certified for payment by the Project Manager, the Contractor shall be entitled to substitute a Retention Money Security guarantee, in the form annexed to the particular Conditions or in another form approved by the Procuring Entity and issued by a reputable bank or financial institution selected by the Contractor, for the second half of the Retention Money.

14.9.5 The Procuring Entity shall return the Retention Money Security guarantee to the Contractor within 14 days after receiving a copy of the Performance Certificate.

14.10 Statement at Completion

14.10.1 Within 84 days after receiving the Taking-Over Certificate for the Works, the Contractor shall submit to the Project Manager six copies of a Statement at completion with supporting documents, in accordance with Sub-Clause 14.3 [Application for Interim Payment Certificates], showing:

- a) the value of all work done in accordance with the Contract up to the date stated in the Taking-Over Certificate for the Works,
- b) any further sums which the Contractor considers to be due, and
- c) an estimate of any other amounts which the Contractor considers will become due to him under the Contract. Estimated amounts shall be shown separately in this Statement at completion.

14.10.2 The Project Manager shall then certify in accordance with Sub-Clause 14.6 [Issue of Interim Payment Certificates].

14.10 Application for Final Payment Certificate

14.10.1 Within 56 days after receiving the Performance Certificate, the Contractor shall submit, to the Project Manager, six copies of a draft final statement with supporting documents showing in detail in a form approved by the Project Manager:

- a. The value of all work done in accordance with the Contract, and
- b. Any further sums which the Contractor considers to be due to him under the Contract otherwise.

14.10.2 If the Project Manager disagrees with or cannot verify any part of the draft final statement, the Contractor shall submit such further information as the Project Manager may reasonably require within 28 days from receipt of

said draft and shall make such changes in the draft as may be agreed between them. The Contractor shall then prepare and submit to the Project Manager the final statement as agreed. This agreed statement is referred to in these Conditions as the “Final Statement”.

14.10.3 However, if, following discussions between the Project Manager and the Contractor and any changes to the draft final statement which are agreed, it becomes evident that a dispute exists, the Project Manager shall deliver to the Procuring Entity (with a copy to the Contractor) an Interim Payment Certificate for the agreed parts of the draft final statement. Thereafter, if the dispute is finally resolved under Sub-Clause 20.4 [Obtaining Dispute Board's Decision] or Sub-Clause 20.5 [Amicable Settlement], the Contractor shall then prepare and submit to the Procuring Entity (with a copy to the Project Manager) a Final Statement.

14.11 Discharge

When submitting the Final Statement, the Contractor shall submit a discharge which confirms that the total of the Final Statement represents full and final settlement of all moneys due to the Contractor under or in connection with the Contract. This discharge may state that it becomes effective when the Contractor has received the Performance Security and the outstanding balance of this total, in which event the discharge shall be effective on such date.

14.12 Issue of Final Payment Certificate

14.12.1 Within 28 days after receiving the Final Statement and discharge in accordance with Sub-Clause 14.11 [Application for Final Payment Certificate] and Sub-Clause 14.12 [Discharge], the Project Manager shall deliver, to the Procuring Entity and to the Contractor, the Final Payment Certificate which shall state:

- a. The amount which he fairly determines is finally due, and
- b. after giving credit to the Procuring Entity for all amounts previously paid by the Procuring Entity and for all sums to which the Procuring Entity is entitled, the balance (if any) due from the Procuring Entity to the Contractor or from the Contractor to the Procuring Entity, as the case may be.

14.12.2 If the Contractor has not applied for a Final Payment Certificate in accordance with Sub-Clause 14.11 [Application for Final Payment Certificate] and Sub-Clause 14.12 [Discharge], the Project Manager shall request the Contractor to do so. If the Contractor fails to apply within a period of 28 days, the Project Manager shall issue the Final Payment Certificate for such amount as she fairly determines to be due.

14.13 Cessation of Procuring Entity's Liability

14.13.1 The Procuring Entity shall not be liable to the Contractor for any matter or thing under or in connection with the Contract or execution of the Works, except to the extent that the Contractor shall have included an amount expressly for it:

- a) In the Final Statement and also
- b) (except for matters or things arising after the issue of the Taking-Over Certificate for the Works) in the Statement at completion described in Sub-Clause 14.10 [Statement at Completion].

14.13.2 However, this Sub-Clause shall not limit the Procuring Entity's liability under his indemnification obligations, or the Procuring Entity's liability in any case of fraud, deliberate default or reckless misconduct by the Procuring Entity.

14.14 Currencies of Payment

14.14.1 The Contract Price shall be paid in the currency or currencies named in the Schedule of Payment Currencies. If more than one currency is so named, payments shall be made as follows:

- a) If the Accepted Contract Amount was expressed in Local Currency only:
 - i) The proportions or amounts of the Local and Foreign Currencies, and the fixed rates of exchange to be used for calculating the payments, shall be as stated in the Schedule of Payment Currencies, except as otherwise agreed by both Parties;
 - ii) payments and deductions under Sub-Clause 13.5 [Provisional Sums] and Sub-Clause 13.7 [Adjustments for Changes in Legislation] shall be made in the applicable currencies and proportions; and
 - iii) other payments and deductions under sub-paragraphs (a) to (d) of Sub-Clause 14.3 [Application for Interim Payment Certificates] shall be made in the currencies and proportions specified in sub-paragraph (a) (i) above;

- b) payment of the damages specified in the Particular Conditions of Contract, shall be made in the currencies and proportions specified in the Schedule of Payment Currencies;
- c) other payments to the Procuring Entity by the Contractor shall be made in the currency in which the sum was expended by the Procuring Entity, or in such currency as may be agreed by both Parties;
- d) if any amount payable by the Contractor to the Procuring Entity in a particular currency exceeds the sum payable by the Procuring Entity to the Contractor in that currency, the Procuring Entity may recover the balance of this amount from the sums otherwise payable to the Contractor in other currencies; and
- e) if no rates of exchange are stated in the Schedule of Payment Currencies, they shall be those prevailing on the Base Date and determined by the central bank of Kenya.

14.13.1 Termination by Procuring Entity

14.14.1 Notice to Correct

If the Contractor fails to carry out any obligation under the Contract, the Project Manager may by notice require the Contractor to make good the failure and to remedy it within a specified reasonable time.

14.15 Termination by Procuring Entity

14.15.1 The Procuring Entity shall be entitled to terminate the Contract if the Contractor:

- a. fails to comply with Sub-Clause 4.2 [Performance Security] or with a notice under Sub-Clause 15.1 [Notice to Correct],
- b. abandons the Works or otherwise plainly demonstrates the intention not to continue performance of his obligations under the Contract,
- c. without reasonable excuse fails:
 - i. to proceed with the Works in accordance with Clause 8 [Commencement, Delays and Suspension], or
 - ii. to comply with a notice issued under Sub-Clause 7.5 [Rejection] or Sub-Clause 7.6 [Remedial Work], within 28 days after receiving it,
- d. subcontracts the major part or whole of the Works or assigns the Contract without the agreement with Procuring Entity,
- e. becomes bankrupt or insolvent, goes into liquidation, has a receiving or administration order made against him, compounds with his creditors, or carries on business under a receiver, trustee or manager for the benefit of his creditors, or if any act is done or event occurs which (under applicable Laws) has a similar effect to any of these acts or events, or
- f. gives or offers to give (directly or indirectly) to any person any bribe, gift, gratuity, commission or other thing of value, as an inducement or reward:
 - i. for doing or for bearing to do any action in relation to the Contract, or
 - ii. for showing or for bearing to show favor or disfavor to any person in relation to the Contract, or
 - iii. if any of the Contractor's Personnel, agents or Subcontractors gives or offers to give (directly or indirectly) to any person any such inducement or reward as is described in this sub-paragraph (f).
- g. However, lawful inducements and rewards to Contractor's Personnel shall not entitle termination, or based on reasonable evidence, has engaged in Fraud and Corruption as defined in paragraph 2.2 of the Appendix B to these General Conditions, in competing for or in executing the Contract.

14.15.2 In any of these events or circumstances, the Procuring Entity may, upon giving 14 days' notice to the Contractor, terminate the Contract and expel the Contractor from the Site. However, in the case of sub-paragraph (e) or (f) or (g), the Procuring Entity may by notice terminate the Contract immediately.

14.15.3 The Procuring Entity's election to terminate the Contract shall not prejudice any other rights of the Procuring Entity, under the Contract or otherwise.

14.15.4 The Contractor shall then leave the Site and deliver any required Goods, all Contractor's Documents, and other design documents made by or for him, to the Project Manager. However, the Contractor shall use his Lowest efforts to comply immediately with any reasonable instructions included in the notice (i) for the assignment of any subcontract, and (ii) for the protection of life or property or for the safety of the Works.

14.15.5 After termination, the Procuring Entity may complete the Works and/ or arrange for any other entities to do so. The Procuring Entity and these entities may then use any Goods, Contractor's Documents and other design documents made by or on behalf of the Contractor.

14.15.6 The Procuring Entity shall then give notice that the Contractor's Equipment and Temporary Works will be released to the Contractor at or near the Site. The Contractor shall promptly arrange their removal, at the risk and cost of the Contractor. However, if by this time the Contractor has failed to make a payment due to the Procuring Entity, these items may be sold by the Procuring Entity in order to recover this payment. Any balance of the proceeds shall then be paid to the Contractor.

14.16 Valuation at Date of Termination

As soon as practicable after a notice of termination under Sub-Clause 15.2 [Termination by Procuring Entity] has taken effect, the Project Manager shall proceed in accordance with Sub-Clause 3.5 [Determinations] to agree or determine the value of the Works, Goods and Contractor's Documents, and any other sums due to the Contractor for work executed in accordance with the Contract.

14.17 Payment after Termination

After a notice of termination under Sub-Clause 15.2 [Termination by Procuring Entity] has taken effect, the Procuring Entity may:

- a) Proceed in accordance with Sub-Clause 2.5 [Procuring Entity's Claims],
- b) withhold further payments to the Contractor until the costs of execution, completion and remedying of any defects, damages for delay incompletion (if any), and all other costs incurred by the Procuring Entity, have been established, and/or
- c) recover from the Contractor any losses and damages incurred by the Procuring Entity and any extra costs of completing the Works, after allowing for any sum due to the Contractor under Sub-Clause 15.3 [Valuation at Date of Termination]. After recovering any such losses, damages and extra costs, the Procuring Entity shall pay any balance to the Contractor.

14.18 Procuring Entity's Entitlement to Termination for Convenience

The Procuring Entity shall be entitled to terminate the Contract, at any time for the Procuring Entity's convenience, by giving notice of such termination to the Contractor. The termination shall take effect 28 days after the later of the dates on which the Contractor receives this notice or the Procuring Entity returns the Performance Security. The Procuring Entity shall not terminate the Contract under this Sub-Clause in order to execute the Works himself or to arrange for the Works to be executed by another contractor or to avoid a termination of the Contract by the Contractor under Clause 16.2 [Termination by Contractor].

After this termination, the Contractor shall proceed in accordance with Sub-Clause 16.3 [Cessation of Work and Removal of Contractor's Equipment] and shall be paid in accordance with Sub-Clause 16.4 [Payment on Termination].

14.19 Fraud and Corruption

The Procuring Entity requires compliance with the Kenya Government's Anti-Corruption Laws and its prevailing sanctions.

14.20 Corrupt gifts and payments of commission

14.20.1 The Contractor shall not;

- a. Offer or give or agree to give to any person in the service of the Procuring Entity any gift or consideration of any kind as an inducement or reward for doing or for bearing to do or for having done or for borne to do any act in relation to the obtaining or execution of this or any other Contract for the Procuring Entity or for showing or for bearing to show favour or disfavour to any person in relation to this or any other contract for the Procuring Entity.
- b. Enter in to this or any other contract with the Procuring Entity in connection with which commission has been paid or agreed to be paid by him or on his behalf or to his knowledge, unless before the Contract is made particulars of any such commission and of the terms and conditions of any agreement for the payment thereof have been disclosed in writing to the Procuring Entity.

15.7.1 Any breach of this Condition by the Contractor or by any one employed by him or acting on his behalf (whether

15 Suspension and Termination by Contractor

15.15 Contractor's Entitlement to Suspend Work

- 15.15.1 If the Project Manager fails to certify in accordance with Sub-Clause 14.6 [Issue of Interim Payment Certificates] or the Procuring Entity fails to comply with Sub-Clause 2.4 [Procuring Entity's Financial Arrangements] or Sub-Clause 14.7 [Payment], the Contractor may, after giving not less than 21 days' notice to the Procuring Entity, suspend work (or reduce the rate of work) unless and until the Contractor has received the Payment Certificate, reasonable evidence or payment, as the case may be and as described in the notice.
- 15.15.2 The Contractor's action shall not prejudice his entitlements to financing charges under Sub-Clause 14.8 [Delayed Payment] and to termination under Sub-Clause 16.2 [Termination by Contractor].
- 15.15.3 If the Contractor subsequently receives such Payment Certificate, evidence or payment (as described in the relevant Sub-Clause and in the above notice) before giving a notice of termination, the Contractor shall resume normal working as soon as is reasonably practicable.
- 15.15.4 If the Contractor suffers delay and/ or incurs Cost as a result of suspending work (or reducing the rate of work) in accordance with this Sub-Clause, the Contractor shall give notice to the Project Manager and shall be entitled subject to Sub-Clause 20.1 [Contractor's Claims] to:
- an extension of time for any such delay, if completion is or will be delayed, under Sub-Clause 8.4 [Extension of Time for Completion], and
 - payment of any such Cost-plus profit, which shall be included in the Contract Price.
- 15.15.5 After receiving this notice, the Project Manager shall proceed in accordance with Sub-Clause 3.5 [Determinations] to agree or determine these matters.

15.16 Termination by Contractor

- 15.16.1 The Contractor shall be entitled to terminate the Contract if:
- the Contractor does not receive the reasonable evidence within 45 days after giving notice under Sub-Clause 16.1 [Contractor's Entitlement to Suspend Work] in respect of a failure to comply with Sub-Clause
 - 2.4 [Procuring Entity's Financial Arrangements],
 - the Project Manager fails, within 45 days after receiving a Statement and supporting documents, to issue the relevant Payment Certificate,
 - the Contractor does not receive the amount due under an Interim Payment Certificate within 45 days after the expiry of the time stated in Sub-Clause 14.7 [Payment] within which payment is to be made (except for deductions in accordance with Sub-Clause 2.5 [Procuring Entity's Claims]),
 - the Procuring Entity substantially fails to perform his obligations under the Contract in such manner as to materially and adversely affect the economic balance of the Contract and/ or the ability of the Contractor to perform the Contract,
 - the Procuring Entity fails to comply with Sub-Clause 1.6 [Contract Agreement] or Sub-Clause 1.7 [Assignment],
 - a prolonged suspension affects the whole of the Works as described in Sub-Clause 8.11 [Prolonged Suspension], or
 - the Procuring Entity becomes bankrupt or insolvent, goes into liquidation, has a receiving or administration order made against him, compounds with his creditors, or carries on business under a receiver, trustee or manager for the benefit of his creditors, or if any act is done or event occurs which (under applicable Laws) has a similar effect to any of these acts or events.
 - The Contractor does not receive the Project Manager's instruction recording the agreement of both Parties on the fulfilment of the conditions for the Commencement of Works under Sub-Clause 8.1 [Commencement of Works].
- 15.16.2 In any of these events or circumstances, the Contractor may, upon giving 14 days' notice to the Procuring Entity, terminate the Contract. However, in the case of sub-paragraph (f) or (g), the Contractor may by notice terminate the Contract immediately.

15.16.3 The Contractor' selection to terminate the Contract shall not prejudice any other rights of the Contractor, under the Contractor otherwise.

15.17 Cessation of Work and Removal of Contractor's Equipment

After a notice of termination under Sub-Clause 15.5 [Procuring Entity's Entitlement to Termination for Convenience], Sub-Clause 16.2 [Termination by Contractor] or Sub-Clause 19.6 [Optional Termination, Payment and Release] has taken effect, the Contractor shall promptly:

- a) Cease all further work, except for such work as may have been instructed by the Project Manager for the protection of life or property or for the safety of the Works,
- b) hand over Contractor's Documents, Plant, Materials and other work, for which the Contractor has received payment, and
- c) remove all other Goods from the Site, except as necessary for safety, and leave the Site.

15.18 Payment on Termination

After a notice of termination under Sub-Clause 16.2 [Termination by Contractor] has taken effect, the Procuring Entity shall promptly:

- a) Return the Performance Security to the Contractor,
- b) pay the Contractor in accordance with Sub-Clause 19.6 [Optional Termination, Payment and Release], and
- c) pay to the Contractor the amount of any loss or damage sustained by the Contractor as a result of this termination.

17. Risk and Responsibility

17.1 Indemnities

17.1.1 The Contractor shall indemnify and hold harmless the Procuring Entity, the Procuring Entity's Personnel, and their respective agents, against and from all claims, damages, losses and expenses (including legal fees and expenses) in respect of:

- a. Bodily injury, sickness, disease or death, of any person whatsoever arising out of or in the course of or by reason of the Contractor's design (if any), the execution and completion of the Works and the remedying of any defects, unless attributable to any negligence, willful act or breach of the Contract by the Procuring Entity, the Procuring Entity's Personnel, or any of their respective agents, and
- b. Damage to or loss of any property, real or personal (other than the Works), to the extent that such damage or loss arises out of or in the course of or by reason of the Contractor's design (if any), the execution and completion of the Works and the remedying of any defects, unless and to the extent that any such damage or loss is attributable to any negligence, willful act or breach of the Contract by the Procuring Entity, the Procuring Entity's Personnel, their respective agents, or any one directly or indirectly employed by any of them.

17.1.2 The Procuring Entity shall indemnify and hold harmless the Contractor, the Contractor's Personnel, and their respective agents, against and from all claims, damages, losses and expenses (including legal fees and expenses) in respect of (1) bodily injury, sickness, disease or death, which is attributable to any negligence, willful act or breach of the Contract by the Procuring Entity, the Procuring Entity's Personnel, or any of their respective agents, and (2) the matters for which liability may be excluded from insurance cover, as described in sub-paragraphs (d) (i), (ii) and (iii) of Sub-Clause 18.3 [Insurance Against Injury to Persons and Damage to Property].

17.2 Contractor's Care of the Works

17.2.1 The Contractor shall take full responsibility for the care of the Works and Goods from the Commencement Date until the Taking-Over Certificate is issued (or is so deemed to be issued under Sub-Clause 10.1 [Taking Over of the Works and Sections]) for the Works, when responsibility for the care of the Works shall pass to the Procuring Entity. If a Taking-Over Certificate is issued (or is so deemed to be issued) for any Section or part of the Works, responsibility for the care of the Section or part shall then pass to the Procuring Entity.

17.2.2 After responsibility has accordingly passed to the Procuring Entity, the Contractor shall take responsibility for the care of any work which is outstanding on the date stated in a Taking-Over Certificate, until this outstanding work has been completed.

17.2.3 If any loss or damage happens to the Works, Goods or Contractor's Documents during the period when the Contractor is responsible for their care, from any cause not listed in Sub-Clause 17.3 [Procuring Entity's Risks], the Contractor shall rectify the loss or damage at the Contractor's risk and cost, so that the Works, Goods and Contractor's Documents conform with the Contract.

17.2.4 The Contractor shall be liable for any loss or damage caused by any actions performed by the Contractor after a Taking-Over Certificate has been issued. The Contractor shall also be liable for any loss or damage which occurs after a Taking-Over Certificate has been issued and which arose from a previous event for which the Contractor was liable.

17.3 Procuring Entity's Risks

The risks referred to in Sub-Clause 17.4 [Consequences of Procuring Entity's Risks] below, insofar as they directly affect the execution of the Works in Kenya, are:

- a) War hostilities (whether war be declared or not),
- b) rebellion, riot, commotion or disorder, terrorism, sabotage by persons other than the Contractor's Personnel,
- c) explosive materials, ionizing radiation or contamination by radio-activity, except as may be attributable to the Contractor's use of such explosives, radiation or radio-activity,
- d) pressure waves caused by aircraft or other aerial devices travelling at sonic or supersonic speeds,
- e) use or occupation by the Procuring Entity of any part of the Permanent Works, except as may be specified in the Contract,
- f) design of any part of the Works by the Procuring Entity's Personnel or by others for whom the Procuring Entity is responsible, and
- g) any operation of the forces of nature which is Unforeseeable or against which an experienced contractor could not reasonably have been expected to have taken adequate preventive precautions.

17.4 Consequences of Procuring Entity's Risks

17.4.1 If and to the extent that any of the risks listed in Sub-Clause 17.3 above results in loss or damage to the Works, Goods or Contractor's Documents, the Contractor shall promptly give notice to the Project Manager and shall rectify this loss or damage to the extent required by the Project Manager.

17.4.2 If the Contractor suffers delay and/or incurs Cost from rectifying this loss or damage, the Contractor shall give a further notice to the Project Manager and shall be entitled subject to Sub-Clause 20.1 [Contractor's Claims] to:

- (a) An extension of time for any such delay, if completion is or will be delayed, under Sub-Clause 8.4 [Extension of Time for Completion], and
- (b) Payment of any such Cost, which shall be included in the Contract Price. In the case of sub-paragraphs (f) and (g) of Sub-Clause 17.3 [Procuring Entity's Risks], Cost plus profit shall be payable.

17.4.3 After receiving this further notice, the Project Manager shall proceed in accordance with Sub-Clause 3.5 [Determinations] to agree or determine these matters.

17.5 Intellectual and Industrial Property Rights

17.5.1 In this Sub-Clause, "infringement" means an infringement (or alleged infringement) of any patent, registered design, copyright, trademark, tradename, trade secret or other intellectual or industrial property right relating to the Works; and "claim" means a claim (or proceedings pursuing a claim) alleging an infringement.

17.5.2 Whenever a Party does not give notice to the other Party of any claim within 28 days of receiving the claim, the first Party shall be deemed to have waived any right to indemnity under this Sub-Clause.

17.5.3 The Procuring Entity shall indemnify and hold the Contractor harmless against and from any claim alleging an infringement which is or was:

- a) An unavoidable result of the Contractor's compliance with the Contract, or
- b) A result of any Works being used by the Procuring Entity:
 - i) For a purpose other than that indicated by, or reasonably to be inferred from, the Contract, or
 - ii) in conjunction with anything not supplied by the Contractor, unless such use was disclosed to the Contractor prior to the Base Date or is stated in the Contract.

17.5.4 The Contractor shall indemnify and hold the Procuring Entity harmless against and from any other claim which arises out of or in relation to (i) the manufacture, use, sale or import of any Goods, or (ii) any design for which the Contractor is responsible.

17.5.5 If a Party is entitled to be indemnified under this Sub-Clause, the indemnifying Party may (at its cost) conduct negotiations for the settlement of the claim, and any litigation or arbitration which may arise from it. The other Party shall, at the request and cost of the indemnifying Party, assist in contesting the claim. This other Party (and its Personnel) shall not make any admission which might be prejudicial to the indemnifying Party, unless the indemnifying Party failed to take over the conduct of any negotiations, litigation or arbitration upon being requested to do so by such other Party.

17.6 Limitation of Liability

17.6.1 Neither Party shall be liable to the other Party for loss of use of any Works, loss of profit, loss of any contractor for any indirect or consequential loss or damage which may be suffered by the other Party in connection with the Contract, other than as specifically provided in Sub-Clause 8.7 [Delay Damages]; Sub-Clause 11.2 [Cost of Remedying Defects]; Sub-Clause 15.4 [Payment after Termination]; Sub-Clause 16.4 [Payment on Termination]; Sub-Clause 17.1 [Indemnities]; Sub-Clause 17.4(b) [Consequences of Procuring Entity's Risks] and Sub-Clause 17.5 [Intellectual and Industrial Property Rights].

17.6.2 The total liability of the Contractor to the Procuring Entity, under or in connection with the Contract other than under Sub-Clause 4.19 [Electricity, Water and Gas], Sub-Clause 4.20 [Procuring Entity's Equipment and Free-Issue Materials], Sub-Clause 17.1 [Indemnities] and Sub-Clause 17.5 [Intellectual and Industrial Property Rights], shall not exceed the sum resulting from the application of a multiplier (less or greater than one) to the Accepted Contract Amount, as stated in the **Particular Conditions of Contract**, or (if such multiplier or other sum is not so stated) the Accepted Contract Amount.

17.6.3 This Sub-Clause shall not limit liability in any case of fraud, deliberate default or reckless misconduct by the defaulting Party.

17.7 Use of Procuring Entity's Accommodation/ Facilities

17.7.5 The Contractor shall take full responsibility for the care of the Procuring Entity provided accommodation and facilities, if any, as detailed in the Specification, from the respective dates of hand-over to the Contractor until cessation of occupation (where hand-over or cessation of occupation may take place after the date stated in the Taking-Over Certificate for the Works).

17.7.6 If any loss or damage happens to any of the above items while the Contractor is responsible for their care arising from any cause whatsoever other than those for which the Procuring Entity is liable, the Contractor shall, at his own cost, rectify the loss or damage to the satisfaction of the Project Manager.

18 Insurance

18.1 General Requirements for Insurances

18.1.1 In this Clause, "insuring Party" means, for each type of insurance, the Party responsible for effecting and maintaining the insurance specified in the relevant Sub-Clause.

18.1.2 Wherever the Contractor is the insuring Party, each insurance shall be effected with insurers and in terms approved by the Procuring Entity. These terms shall be consistent with any terms agreed by both Parties before the date of the Letter of Acceptance. This agreement of terms shall take precedence over the provisions of this Clause.

18.1.3 Wherever the Procuring Entity is the insuring Party, each insurance shall be effected with insurers and in terms acceptable to the Contractor. These terms shall be consistent with any terms agreed by both Parties before the date of the Letter of Acceptance. This agreement of terms shall take precedence over the provisions of this Clause.

18.1.4 If a policy is required to indemnify joint insured, the cover shall apply separately to each insured as though a separate policy had been issued for each of the joint insured. If a policy indemnifies additional joint insured, namely in addition to the insured specified in this Clause, (i) the Contractor shall act under the policy on behalf of these additional joint insured except that the Procuring Entity shall act for Procuring Entity's Personnel, (ii) additional joint insured shall not be entitled to receive payments directly from the insurer or to have any other direct dealings with the insurer, and (iii) the insuring Party shall require all additional joint insured to comply with the conditions stipulated in the policy.

- 18.1.5 Each policy insuring against loss or damage shall provide for payments to be made in the currencies required to rectify the loss or damage. Payments received from insurers shall be used for the rectification of the loss or damage.
- 18.1.6 The relevant insuring Party shall, within the respective periods stated in **the Particular Conditions of Contract** (calculated from the Commencement Date), submit to the other Party:
- a. Evidence that the insurances described in this Clause have been effected, and
 - b. copies of the policies for the insurances described in Sub-Clause 18.2 [Insurance for Works and Contractor's Equipment] and Sub-Clause 18.3 [Insurance against Injury to Persons and Damage to Property].
- 18.1.7 When each premium is paid, the insuring Party shall submit evidence of payment to the other Party. Whenever evidence or policies are submitted, the insuring Party shall also give notice to the Project Manager.
- 18.1.8 Each Party shall comply with the conditions stipulated in each of the insurance policies. The insuring Party shall keep the insurers informed of any relevant changes to the execution of the Works and ensure that insurance is maintained in accordance with this Clause.
- 18.1.9 Neither Party shall make any material alteration to the terms of any insurance without the prior approval of the other Party. If an insurer makes (or at tempts to make) any alteration, the Party first notified by the insurer shall promptly give notice to the other Party.
- 18.1.10 If the insuring Party fails to effect and keep in force any of the insurances it is required to effect and maintain under the Contract, or fails to provide as its factory evidence and copies of policies in accordance with this Sub-Clause, the other Party may (at its option and without prejudice to any other right or remedy) effect insurance for the relevant coverage and pay the premiums due. The insuring Party shall pay the amount of these premiums to the other Party, and the Contract Price shall be adjusted accordingly.
- 18.1.11 Nothing in this Clause limits the obligations, liabilities or responsibilities of the Contractor or the Procuring Entity, under the other terms of the Contract or otherwise. Any amounts not insured or not recovered from the insurers shall be borne by the Contractor and/or the Procuring Entity.
- 18.1.12 Procuring Entity in accordance with these obligations, liabilities or responsibilities. However, if the insuring Party fails to effect and keep in force an insurance which is available and which it is required to effect and maintain under the Contract, and the other Party neither approves the omission nor effects insurance for the coverage relevant to this default, any moneys which should have been recoverable under this insurance shall be paid by the insuring Party.
- 18.1.13 Payments by one Party to the other Party shall be subject to Sub-Clause 2.5 [Procuring Entity's Claims] or Sub-Clause 20.1 [Contractor's Claims], as applicable.
- 18.1.14 The Contractor shall be entitled to place all insurance relating to the Contract (including, but not limited to the insurance referred to Clause 18) with insurers from any eligible source country.

18.2 Insurance for Works and Contractor's Equipment

- 18.2.1 The insuring Party shall insure the Works, Plant, Materials and Contractor's Documents for not less than the full reinstatement cost including the costs of demolition, removal of debris and professional fees and profit. This insurance shall be effective from the date by which the evidence is to be submitted under sub-paragraph (a) of Sub-Clause 18.1 [General Requirements for Insurances], until the date of issue of the Taking-Over Certificate for the Works.
- 18.2.2 The insuring Party shall maintain this insurance to provide cover until the date of issue of the Performance Certificate, for loss or damage for which the Contractor is liable arising from a cause occurring prior to the issue of the Taking-Over Certificate, and for loss or damage caused by the Contractor in the course of any other operations (including those under Clause 11 [Defects Liability]).
- 18.2.3 The insuring Party shall insure the Contractor's Equipment for not less than the full replacement value, including delivery to Site. For each item of Contractor's Equipment, the insurance shall be effective while it is being transported to the Site and until it is no longer required as Contractor's Equipment.
- 18.2.4 Unless otherwise stated in the Particular Conditions, insurances under this Sub-Clause:
- a. Shall be effected and maintained by the Contractor as insuring Party,

- b. shall be in the joint names of the Parties, who shall be jointly entitled to receive payments from the insurers, payments being held or allocated to the Party actually bearing the costs of rectifying the loss or damage,
- c. shall cover all loss and damage from any cause not listed in Sub-Clause 17.3 [Procuring Entity's Risks],
- d. shall also cover, to the extent specifically required in the tendering documents of the Contract, loss or damage to a part of the Works which is attributable to the use or occupation by the Procuring Entity of another part of the Works, and loss or damage from the risks listed in sub-paragraphs (c), (g) and (h) of Sub-Clause 17.3 [Procuring Entity's Risks], excluding (in each case) risks which are not insurable at commercially reasonable terms, with deductibles per occurrence of not more than the amount stated **in the Particular Conditions of Contract** (if an amount is not so stated, this sub-paragraph (d) shall not apply), and
- e. may however exclude loss of, damage to, and rein statement of:
 - a. a part of the Works which is in a defective condition due to a defect in its design, materials or workmanship (but cover shall include any other parts which are lost or damaged as a direct result of this defective condition and not as described in sub-paragraph (ii) below),
 - b. a part of the Works which is lost or damaged in order to rein state any other part of the Works if this other part is in a defective condition due to a defect in its design, materials or workmanship,
 - c. a part of the Works which has been taken over by the Procuring Entity, except to the extent that the Contractor is liable for the loss or damage, and
 - d. Goods while they are not in Kenya, subject to Sub-Clause 14.5 [Plant and Materials intended for the Works].

18.2.5 If, more than one year after the Base Date, the cover described in sub-paragraph (d) above ceases to be available at commercially reasonable terms, the Contractor shall (as insuring Party) give notice to the Procuring Entity, with supporting particulars. The Procuring Entity shall then (i) be entitled subject to Sub-Clause 2.5 [Procuring Entity's Claims] to payment of an amount equivalent to such commercially reasonable terms as the Contractor should have expected to have paid for such cover, and (ii) be deemed, unless he obtains the cover at commercially reasonable terms, to have approved the omission under Sub-Clause 18.1 [General Requirements for Insurances].

18.3 Insurance against Injury to Persons and Damage to Property

18.3.1 The insuring Party shall insure against each Party's liability for any loss, damage, death or bodily injury which may occur to any physical property (except things insured under Sub-Clause 18.2 [Insurance for Works and Contractor's Equipment]) or to any person (except persons insured under Sub-Clause 18.4 [Insurance for Contractor's Personnel]), which may arise out of the Contractor's performance of the Contract and occurring before the issue of the Performance Certificate.

18.3.2 This insurance shall be for a limit per occurrence of not less than the amount stated in **the Particular Conditions of Contract**, with no limit on the number of occurrences. If an amount is not stated in the **Particular Conditions of Contract**, this Sub-Clause shall not apply.

18.3.3 Unless otherwise stated in the Particular Conditions, the insurances specified in this Sub-Clause:

- a. Shall be effected and maintained by the Contractor as insuring Party,
- b. Shall be in the joint names of the Parties,
- c. shall be extended to cover liability for all loss and damage to the Procuring Entity's property (except things insured under Sub-Clause 18.2) arising out of the Contractor's performance of the Contract, and
- d. may however exclude liability to the extent that it arises from:
 - i. the Procuring Entity's right to have the Permanent Works executed on, over, under, in or
 - ii. through any land, and to occupy this land for the Permanent Works,
 - iii. damage which is an unavoidable result of the Contractor's obligations to execute the
 - iv. Works and remedy any defects, and
 - v. A cause listed in Sub-Clause 17.3 [Procuring Entity's Risks], except to the extent that cover is
 - vi. available at commercially reasonable terms.

18.4 Insurance for Contractor's Personnel

18.4.1 The Contractor shall effect and maintain insurance against liability for claims, damages, losses and expenses (including legal fees and expenses) arising from injury, sickness, disease or death of any person employed by the

- 18.4.2 The insurance shall cover the Procuring Entity and the Project Manager against liability for claims, damages, losses and expenses (including legal fees and expenses) arising from injury, sickness, disease or death of any person employed by the Contractor or any other of the Contractor's Personnel, except that this insurance may exclude losses and claims to the extent that they arise from any act or neglect of the Procuring Entity or of the Procuring Entity's Personnel.
- 18.4.3 The insurance shall be maintained in full force and effect during the whole time that these personnel are assisting in the execution of the Works. For a Subcontractor's employees, the insurance may be effected by the Subcontractor, but the Contractor shall be responsible for compliance with this Clause.

19 Force Majeure

19.1 Definition of Force Majeure

- 19.1.1 In this Clause, "Force Majeure" means an exceptional event or circumstance:
- a. Which is beyond a Party's control,
 - b. Which such Party could not reasonably have provided against before entering in to the Contract,
 - c. which, having arisen, such Party could not reasonably have avoided or overcome, and
 - d. which is not substantially attributable to the other Party.
- 19.1.2 Force Majeure may include, but is not limited to, exceptional events or circumstances of the kind listed below, so long as conditions (a) to (d) above are satisfied:
- i) war, hostilities (whether war be declared or not), invasion, act of foreign enemies,
 - ii) rebellion, terrorism, sabotage by persons other than the Contractor's Personnel, revolution, insurrection, military or usurped power, or civil war,
 - iii) riot, commotion, disorder, strike or lockout by persons other than the Contractor's Personnel,
 - iv) munitions of war, explosive materials, ionizing radiation or contamination by radio-activity, except as may be attributable to the Contractor's use of such munitions, explosives, radiation or radio-activity, and
 - v) natural catastrophes such as earthquake, hurricane, typhoon or volcanic activity.

19.2 Notice of Force Majeure

- 19.2.1 If a Party is or will be prevented from performing its substantial obligations under the Contract by Force Majeure, then it shall give notice to the other Party of the event or circumstances constituting the Force Majeure and shall specify the obligations, the performance of which is or will be prevented. The notice shall be given within 14 days after the Party became aware, or should have become aware, of the relevant event or circumstance constituting Force Majeure.
- 19.2.2 The Party shall, having given notice, be excused performance of its obligations for so long as such Force Majeure prevents it from performing them.
- 19.2.3 Notwithstanding any other provision of this Clause, Force Majeure shall not apply to obligations of either Party to make payments to the other Party under the Contract.

19.3 Duty to Minimize Delay

Each Party shall at all times use all reasonable endeavors to minimize any delay in the performance of the Contract as a result of Force Majeure. A Party shall give notice to the other Party when it ceases to be affected by the Force Majeure.

19.4 Consequences of Force Majeure

- 19.4.1 If the Contractor is prevented from performing his substantial obligations under the Contract by Force Majeure of which notice has been given under Sub-Clause 19.2 [Notice of Force Majeure], and suffers delay and/or incurs Cost by reason of such Force Majeure, the Contractor shall be entitled subject to Sub-Clause 20.1 [Contractor's Claims] to:
- a. an extension of time for any such delay, if completion is or will be delayed, under Sub-Clause 8.4 [Extension

of Time for Completion], and

- b. if the event or circumstance is of the kind described in sub-paragraphs (i) to (iv) of Sub-Clause 19.1 [Definition of Force Majeure] and, in sub-paragraphs(ii)to(iv), occurs in Kenya, payment of any such Cost, including the costs of rectifying or replacing the Works and/or Goods damaged or destroyed by Force Majeure, to the extent they are not indemnified through the insurance policy referred to in Sub- Clause 18.2[Insurance for Works and Contractor's Equipment].

19.4.2 After receiving this notice, the Project Manager shall proceed in accordance with Sub-Clause 3.5 [Determinations] to agree or determine these matters.

19.5 Force Majeure Affecting Subcontractor

If any Subcontractor is entitled under any contract or agreement relating to the Works to relief from force majeure on terms additional to or broader than those specified in this Clause, such additional or broader force majeure events or circumstances shall not excuse the Contractor's non-performance or entitle him to relief under this Clause.

19.6 Optional Termination, Payment and Release

19.6.1 If the execution of substantially all the Works in progress is prevented for a continuous period of 84days by reason of Force Majeure of which notice has been given under Sub-Clause19.2 [Notice of Force Majeure], or for multiple periods which total more than 140days due to the same notified Force Majeure, then either Party may give to the other Party a notice of termination of the Contract. In this event, the termination shall take effect 7 days after the notice is given, and the Contractor shall proceed in accordance with Sub-Clause 16.3 [Cessation of Work and Removal of Contractor's Equipment].

19.6.2 Upon such termination, the Project Manager shall determine the value of the work done and issue a Payment Certificate which shall include:

- a. The amounts payable for any work carried out for which a price is stated in the Contract;
- b. The Cost of Plant and Materials ordered for the Works which have been delivered to the Contractor, or of which the Contractor is liable to accept delivery: this Plant and Materials shall become the property of (and bear the risk of) the Procuring Entity when paid for by the Procuring Entity, and the Contractor shall place the same at the Procuring Entity's disposal;
- c. other Cost or liabilities which in the circumstances were reasonably and necessarily incurred by the Contractor in the expectation of completing the Works;
- d. the Cost of removal of Temporary Works and Contractor's Equipment from the Site and the return of these items to the Contractor's works in his Procuring Entity (or to any other destination at no greater cost); and
- e. the Cost of repatriation of the Contractor's staff and labor employed wholly in connection with the Works at the date of termination.

19.7 Release from Performance

Notwithstanding any other provision of this Clause, if any event or circumstance outside the control of the Parties (including, but not limited to, Force Majeure) arises which makes it impossible or unlawful for either or both Parties to fulfil its or their contractual obligations or which, under the law governing the Contract, entitles the Parties to be released from further performance of the Contract, then upon notice by either Party to the other Party of such event or circumstance:

- a) The Parties shall be discharged from further performance, without prejudice to the rights of either Party in respect of any previous breach of the Contract, and
- b) The sum payable by the Procuring Entity to the Contractor shall be the same as would have been payable under Sub-Clause19.6 [Optional Termination, Payment and Release] if the Contract had been terminated under Sub-Clause19.6.

20 Settlement of Claims and Disputes

20.1 Contractor's Claims

20.1.1 If the Contractor considers himself to be entitled to any extension of the Time for Completion and/or any

additional payment, under any Clause of these Conditions or otherwise in connection with the Contract, the Contractor shall give notice to the Project Manager, describing the event or circumstance giving rise to the claim. The notice shall be given as soon as practicable, and not later than 28 days after the Contractor became aware, or should have become aware, of the event or circumstance.

- 20.1.2 If the Contractor fails to give notice of a claim within such period of 28 days, the Time for Completion shall not be extended, the Contractor shall not be entitled to additional payment, and the Procuring Entity shall be discharged from all liability in connection with the claim. Otherwise, the following provisions of this Sub-Clause shall apply.
- 20.1.3 The Contractor shall also submit any other notices which are required by the Contract, and supporting particulars for the claim, all as relevant to such event or circumstance.
- 20.1.4 The Contractor shall keep such contemporary records as may be necessary to substantiate any claim, either on the Site or at another location acceptable to the Project Manager. Without admitting the Procuring Entity's liability, the Project Manager may, after receiving any notice under this Sub-Clause, monitor the record-keeping and/or instruct the Contractor to keep further contemporary records. The Contractor shall permit the Project Manager to inspect all these records, and shall (if instructed) submit copies to the Project Manager.
- 20.1.5 Within 42 days after the Contractor became aware (or should have become aware) of the event or circumstance giving rise to the claim, or within such other period as may be proposed by the Contractor and approved by the Project Manager, the Contractor shall send to the Project Manager a fully detailed claim which includes full supporting particulars of the basis of the claim and of the extension of time and/or additional payment claimed. If the event or circumstance giving rise to the claim has a continuing effect:
- a) This fully detailed claim shall be considered as interim;
 - b) The Contractor shall send further interim claims at monthly intervals, giving the accumulated delay and/or amount claimed, and such further particulars as the Project Manager may reasonably require; and
 - c) The Contractor shall send a final claim within 28 days after the end of the effects resulting from the event or circumstance, or within such other period as may be proposed by the Contractor and approved by the Project Manager.
- 20.1.6 Within 42 days after receiving a claim or any further particulars supporting a previous claim, or within such other period as may be proposed by the Project Manager and approved by the Contractor, the Project Manager shall respond with approval, or with disapproval and detailed comments. He may also request any necessary further particulars, but shall nevertheless give his response on the principles of the claim within the above defined time period.
- 20.1.7 Within the above defined period of 42 days, the Project Manager shall proceed in accordance with Sub-Clause 3.5 [Determinations] to agree or determine (i) the extension (if any) of the Time for Completion (before or after its expiry) in accordance with Sub-Clause 8.4 [Extension of Time for Completion], and/or (ii) the additional payment (if any) to which the Contractor is entitled under the Contract.
- 20.1.8 Each Payment Certificate shall include such additional payment for any claim as has been reasonably substantiated as due under the relevant provision of the Contract. Unless and until the particulars supplied are sufficient to substantiate the whole of the claim, the Contractor shall only be entitled to payment for such part of the claim as he has been able to substantiate.
- 20.1.9 If the Project Manager does not respond within the time frame defined in this Clause, either Party may consider that the claim is rejected by the Project Manager and any of the Parties may refer to Arbitration in accordance with Sub-Clause 20.2 [Settlement of Claims and Disputes].
- 20.1.10 The requirements of this Sub-Clause are in addition to those of any other Sub-Clause which may apply to a claim. If the Contractor fails to comply with this or another Sub-Clause in relation to any claim, any extension of time and/or additional payment shall take account of the extent (if any) to which the failure has prevented or prejudiced proper investigation of the claim, unless the claim is excluded under the second paragraph of this Sub-Clause.

20.2 Amicable Settlement

Where a Notice of Dissatisfaction has been given, both Parties shall attempt to settle the dispute amicably before the commencement of arbitration. However, unless both Parties agree otherwise, the Party giving a Notice of Dissatisfaction in accordance with Sub-Clause 20.1 above should move to commence arbitration after the fifty-sixth day from the day on which a Notice of Dissatisfaction was given, even if no attempt at an amicable settlement has been made.

20.3 Matters that may be referred to arbitration

Notwithstanding anything stated herein the following matters may be referred to arbitration before the practical completion of the Works or abandonment of the Works or termination of the Contract by either party:

- a) The appointment of a replacement Project Manager upon the said person ceasing to act.
- b) Whether or not the issue of an instruction by the Project Manager is empowered by these Conditions.
- c) Whether or not a certificate has been improperly withheld or is not in accordance with these Conditions.
- e) Any dispute arising in respect of war risks or war damage.
- f) All other matters shall only be referred to arbitration after the completion or alleged completion of the Works or termination or alleged termination of the Contract, unless the Procuring Entity and the Contractor agree otherwise in writing.

20.4 Arbitration

20.4.1 Any claim or dispute between the Parties arising out of or in connection with the Contract not settled amicably in accordance with Sub-Clause 20.3 shall be finally settled by arbitration. Arbitration shall be conducted as follows:

- a) If the contract is with foreign contractors, arbitration proceedings shall be administered by the arbitration institution designated in the Particular Conditions of Contract, and conducted under the rules of arbitration of such institution; or, if so specified in the Particular Conditions of Contract, international arbitration in accordance with the arbitration rules of the United Nations Commission on International Trade Law (UNCITRAL); or if neither an arbitration institution nor UNCITRAL arbitration rules are specified in the Particular Conditions of Contract, with proceedings administered by the International Chamber of Commerce (ICC) and conducted under the ICC Rules of Arbitration; by one or more arbitrators appointed in accordance with said arbitration rules;
- b) If the Contract is with national contractors, arbitration with proceedings conducted in accordance with the Arbitration Laws of Kenya.

20.4.2 The place of arbitration shall be the neutral location specified in the Particular Conditions of Contract; and the arbitration shall be conducted in the language for communications defined in Sub-Clause 1.4 [Law and Language].

20.4.3 The arbitrators shall have full power to open up, review and revise any certificate, determination, instruction, opinion or valuation of the Project Manager, relevant to the dispute. Nothing shall disqualify representatives of the Parties and the Project Manager from being called as a witness and giving evidence before the arbitrators on any matter whatsoever relevant to the dispute.

20.4.4 Neither Party shall be limited in the proceedings before the arbitrators to the evidence, or to the reasons for dissatisfaction given in its Notice of Dissatisfaction.

20.4.5 Arbitration may be commenced prior to or after completion of the Works. The obligations of the Parties, and the Project Manager shall not be altered by reason of any arbitration being conducted during the progress of the Works.

20.4.6 The terms of the remuneration of each or all the members of Arbitration shall be mutually agreed upon by the Parties when agreeing the terms of appointment. Each Party shall be responsible for paying one-half of this remuneration.

20.5 National arbitration with proceedings

20.5.1 In case of any claim or dispute, such claim or dispute shall be notified in writing by either party to the other with a request to submit it to arbitration and to concur in the appointment of an Arbitrator within thirty days of the notice. The dispute shall be referred to the arbitration and final decision of a person to be agreed between the parties. Failing agreement to concur in the appointment of an Arbitrator, the Arbitrator shall be appointed, on the request of the applying party, by the Chairman or Vice Chairman of any of the following professional institutions;

- i) Architectural Association of Kenya
- ii) Institute of Quantity Surveyors of Kenya
- iii) Association of Consulting Engineers of Kenya
- iv) Chartered Institute of Arbitrators (Kenya Branch)

- 20.5.2 The institution written to first by the aggrieved party shall take precedence over all other institutions.
- 20.5.3 The arbitration may be on the construction of this Contract or on any matter or thing of whatsoever nature arising thereunder or in connection therewith, including any matter or thing left by this Contract to the discretion of the Project Manager, or the withholding by the Project Manager of any certificate to which the Contractor may claim to be entitled to or the measurement and valuation referred to in clause 23.0 of these conditions, or the rights and liabilities of the parties subsequent to the termination of Contract.
- 20.5.4 Provided that no arbitration proceedings shall be commenced on any claim or dispute where notice of a claim or dispute has not been given by the applying party within ninety days of the occurrence or discovery of the matter or issue giving rise to the dispute.
- 20.5.5 Notwithstanding the issue of a notice as stated above, the arbitration of such a claim or dispute shall not commence unless an attempt has in the first instance been made by the parties to settle such claim or dispute amicably with or without the assistance of third parties. Proof of such attempt shall be required.
- 20.5.6 The Arbitrator shall, without prejudice to the generality of his powers, have powers to direct such measurements, computations, tests or valuations as may in his opinion be desirable in order to determine the rights of the parties and assess and award any sums which ought to have been the subject of or included in any certificate.
- 20.5.7 The Arbitrator shall, without prejudice to the generality of his powers, have powers to open up, review and revise any certificate, opinion, decision, requirement or notice and to determine all matters in dispute which shall be submitted to him in the same manner as if no such certificate, opinion, decision requirement or notice had been given.
- 20.5.8 The award of such Arbitrator shall be final and binding upon the parties.

20.6 Failure to Comply with Arbitrator's Decision

In the event that a Party fails to comply with a final and binding Arbitrator's decision, then the other Party may, without prejudice to any other rights it may have, refer the matter to a competent court of law.

SECTION IX - PARTICULAR CONDITIONS OF CONTRACT

The following Particular Conditions shall supplement the GCC. Whenever there is a conflict, the provisions here in shall prevail over those in the GCC.

Part A - Contract Data

Conditions	Sub-clause	Data
Procuring Entity's name and address	Heading	CHIEF EXECUTIVE OFFICER KENYA BIOVAX INSTITUTE LTD. P.O. BOX 40779-00100 NAIROBI
Name and Reference No. of the Contract	Heading and 3.1.1	TENDER NO. KBI/IFT/OIT/001/2023-2024 W.P. ITEM NO.: D1081 NB/NB/2301 JOB NO. 11221A
Project Manager Name and address	Heading and 3.1.1	WORKS SECRETARY STATE DEPARTMENT FOR PUBLIC WORKS P.O BOX 30743- 00100 NAIROBI
Contractor's Representative's name	4.3.1	To be agreed with Project Manager Team
Key Personnel names	16.9.1	To be agreed with Project Manager Team
Time for Completion	1.1	52 _____ Weeks
Defects Notification Period	1.1	_____ 14 _____ Days
Sections	1.1	<i>If sections are to be used, refer to Table : Summary of sections below</i>
Electronic transmission systems	1.3	
Time for the parties entering into a Contract Agreement	1.6	Within 30days
Commencement Date	8.1.1	To be agreed with Project Manager Team
Time for access to the site	2.1	No later than the Commencement Date, and not later than _____ 14 _____ days after Commencement Date
Project Managers Duties and Authority	3.1.6 (b)(ii)	Variations resulting in an increase of the Accepted Contract Amount in excess of <u>25</u> % shall require approval of the procuring Entity.

Performance Security	4.2.1	The performance security will be in the form of a performance bond in the amount of 10% of the accepted Amount in the same currency(ies) of the accepted contract amount
Normal working hours	6.5	To be agreed with the Project manager Team
Delay damages for the works	8.7 & 14.15.1(b)	0.003 % of the Contract Price per day.
Maximum amount of delay damages	8.7	5 % of the final Contract Price.
Provisional Sums	13.5.(b)(ii)	<i>[If there are Provisional Sums, insert a percentage for adjustment of Provisional Sums]</i> ---25%
Adjustments for Changes in Cost	13.8.3	As per PPRA 2015
Total advance payment	14.2.1	Not Applicable
Repayment amortization rate of advance payment	14.2.5(b)	Not Applicable
Percentage of Retention	14.3.2 (c)	10 %
Limit of Retention Money	14.3.2 (c)	10% of the Accepted Contract Amount
Plant and Materials	14.5(b)(i)	Not applicable
	14.5(C)(i)	Not applicable
Minimum Amount of Interim Payment Certificates	14.6.2	Not applicable
Publishing source of commercial interest rates for financial charges case of delayed payment	14.8.2	annual rate of three percentage points above the mean lending rate of the Central Bank in Kenya currency of payment
Maximum total liability of the Contractor to the Procuring Entity	17.6.2	As per applicable laws

Periods for submission of insurance: a. evidence of insurance. b. Relevant policies	18.1.6	14 days 14 days
Maximum amount of deductibles for insurance of the Procuring Entity's risks	18.2.4 (d)	<i>As per applicable laws</i>
Minimum amount of third-party insurance	18.3.2	<i>As per applicable laws</i>
The place of arbitration	20.4.2	<i>As per the location of Site.</i>

SECTION IX - CONTRACT FORMS

Table of Forms

FORM No. 1 - NOTIFICATION OF INTENTION TO AWARD

FORM No. 2 – REQUEST FOR REVIEW

FORM No. 3 - LETTER OF AWARD

FORM No. 4 - CONTRACT AGREEMENT

FORM No. 5 - PERFORMANCE SECURITY [Option 1 - Unconditional Demand Bank Guarantee]

FORM No. 6- PERFORMANCE SECURITY [Option 2– Performance Bond]

FORM No. 7 - ADVANCE PAYMENT SECURITY

FORM No. 8- RETENTION MONEY SECURITY

FORM NO. 9 BENEFICIAL OWNERSHIP DISCLOSURE

FORMN01: NOTIFICATION OF INTENTION TO AWARD

This Notification of Intention to Award shall be sent to each Tenderer that submitted a Tender. Send this Notification to the Tenderer's Authorized Representative named in the Tender Information Form on the format below.

FORMAT

1. For the attention of Tenderer's Authorized Representative

- i) Name: *[insert Authorized Representative's name]*
- ii) Address: *[insert Authorized Representative's Address]*
- iii) Telephone: *[insert Authorized Representative's telephone/ fax numbers]*
- iv) Email Address: *[insert Authorized Representative's email address]*

[IMPORTANT: insert the date that this Notification is transmitted to Tenderers. The Notification must be sent to all Tenderers simultaneously. This means on the same date and as close to the same time as possible.]

2. Date of transmission: [email] on [date] (local time) This Notification

Is sent by (Name and designation) _____

3. Notification of Intention to Award

- i) Procuring Entity: *[insert the name of the Procuring Entity]*
- ii) Project: *[insert name of project]*
- iii) Contract title: *[insert the name of the contract]*
- iv) ITT No: *[insert ITT reference number from Procurement Plan]*

This Notification of Intention to Award (Notification) notifies you of our decision to award the above contract. The transmission of this Notification begins the Standstill Period. During the Standstill Period, you may:

4. Request a debriefing in relation to the evaluation of your tender by submitting a Procurement-related Complaint in relation to the decision to award the contracts.

- a) The successful tenderers
 - i) Name of successful Tender _____
 - ii) Address of the successful Tender _____
 - iii) Contract price of the successful Tender Kenya Shillings _____
(in words _____)
- b) Other Tenderers

Names of all Tenderers that submitted a Tender. If the Tender's price was evaluated include the evaluated price as well as the Tender price as read out.

S/No.	Name of Tender	Tender Price as read out	Tender's evaluated price (Note a)	One Reason Why Not Evaluated
1				
2				
3				
4				
5				

5. How to request a debriefing
 - a) DEADLINE: The deadline to request a debriefing expires at midnight on *[insert date]* (local time).
 - b) You may request a debriefing in relation to the results of the evaluation of your Tender. If you decide to request a debriefing your written request must be made within three (5) Business Days of receipt of this Notification of Intention to Award.
 - c) Provide the contract name, reference number, name of the Tenderer, contact details; and address the request for debriefing as follows:
 - i) Attention: *[insert full name of person, if applicable]*
 - ii) Title/position: *[insert title / position]*
 - ii) Agency: *[insert name of Procuring Entity]*
 - iii) Email address: *[insert email address]*
 - d) If your request for a debriefing is received within the 3 Days deadline, we will provide the debriefing within five (3) Business Days of receipt of your request. If we are unable to provide the debriefing within this period, the Standstill Period shall be extended by five (3) Days after the date that the debriefing is provided. If this happens, we will notify you and confirm the date that the extended Standstill Period will end.
 - e) The debriefing may be in writing, by phone, video conference call or in person. We shall promptly advise you in writing how the debriefing will take place and confirm the date and time.
 - f) If the deadline to request a debriefing has expired, you may still request a debriefing. In this case, we will provide the debriefing as soon as practicable, and normally no later than fifteen (15) Days from the date of publication of the Contract Award Notice.

6. How to make a complaint
 - a) Period: Procurement-related Complaint challenging the decision to award shall be submitted by midnight, *[insert date]* (local time).
 - b) Provide the contract name, reference number, name of the Tenderer, contact details; and address the Procurement-related Complaint as follows:
 - i) Attention: *[insert full name of person, if applicable]*
 - ii) Title/position: *[insert title / position]*
 - iii) Agency: *[insert name of Procuring Entity]*
 - iv) Email address: *[insert email address]*
 - c) At this point in the procurement process, you may submit a Procurement-related Complaint challenging the decision to award the contract. You do not need to have requested, or received, a debriefing before making this complaint. Your complaint must be submitted within the Standstill Period and received by us before the Standstill Period ends.
 - d) Further information: For more information refer to the Public Procurement and Disposals Act 2015 and its Regulations available from the Website www.ppra.go.ke.

You should read these documents before preparing and submitting your complaint.
 - e) There are four essential requirements:
 - i) You must be an 'interested party'. In this case, that means a Tenderer who submitted a Tender in this tendering process, and is the recipient of a Notification of Intention to Award.
 - ii) The complaint can only challenge the decision to award the contract.
 - iii) You must submit the complaint within the period stated above.
 - iv) You must include, in your complaint, all of the information required to support your complaint.

7. Standstill Period

- i) DEADLINE: The Standstill Period is due to end at midnight on *[insert date]* (local time).
- ii) The Standstill Period lasts ten (14) Days after the date of transmission of this Notification of Intention to Award.
- iii) The Standstill Period may be extended as stated in paragraph Section 5 (d) above.

If you have any questions regarding this Notification please do not hesitate to contact

us. On behalf of the Procuring Entity:

Signature: _____

Name: _____

Title/position:

Telephone: _____

Email: _____

FORM NO. 2- REQUEST FOR REVIEW

FORM FOR REVIEW (r.203(1))

PUBLIC PROCUREMENT ADMINISTRATIVE REVIEW BOARD

APPLICATION NO.....OF.....20.....

BETWEEN

.....**APPLICANT**

AND

.....**RESPONDENT (Procuring Entity)**

Request for review of the decision of the..... (Name of the Procuring Entity ofdated the...day of20.....in the matter of Tender No.....of20..... for (Tender description).

REQUEST FOR REVIEW

I/We.....,the above named Applicant(s), of address: Physical address.....P. O. Box No..... Tel. No.....Email, hereby request the Public Procurement Administrative Review Board to review the whole/part of the above mentioned decision on the following grounds , namely:

- 1.
- 2.

By this memorandum, the Applicant requests the Board for an order/orders that:

- 1.
- 2.

SIGNED (Applicant) Dated on.....day of/...20.....

FOR OFFICIAL USE ONLY Lodged with the Secretary Public Procurement Administrative Review Board on.....day of20.....

SIGNED
Board Secretary

FORM NO 3: LETTER OF AWARD

[letterhead paper of the Procuring

Entity] [date]

To: *[name and address of the Contractor]*

This is to notify you that your Tender dated.....*[date]* for execution of the.....*[name of the Contract and identification number, as given in the Contract Data]* for the Accepted Contract Amount.....*[amount in numbers and words] [name of currency]*, as corrected and modified in accordance with the Instructions to Tenderers, is here by accepted by..... *(name of Procuring Entity)*.

You are requested to furnish the Performance Security within 28days in accordance with the Conditions of Contract, using, for that purpose, one of the Performance Security Forms included in Section VIII, Contract Forms, of the Tender Document.

Authorized Signature: _____

Name and Title of Signatory: _____

Name of Procuring Entity: _____

Attachment: *Contract Agreement*: _____

FORM NO 4: CONTRACT AGREEMENT

THIS AGREEMENT made the _____ day of _____, 20____, between _____ of _____ (hereinafter “the Procuring Entity”), of the one part, and _____ of _____ (hereinafter “the Contractor”), of the other part:

WHEREAS the Procuring Entity desires that the Works known as _____ should be executed by the Contractor, and has accepted a Tender by the Contractor for the execution and completion of these Works and the remedying of any defects there in,

The Procuring Entity and the Contractor agree as follows:

1. In this Agreement words and expressions shall have the same meanings as are respectively assigned to the min the Contract documents referred to.
2. The following documents shall be deemed to form and be read and construed as part of this Agreement. This Agreement shall prevail over all other Contract documents.
 - a) The Letter of Acceptance
 - b) The Letter of Tender
 - c) The addenda Nos _____ (if any)
 - d) The Particular Conditions of Contract
 - e) The General Conditions of Contract;
 - f) The Specifications
 - g) The Drawings; and
 - h) The completed Schedules and any other documents forming part of the contract.
3. In consideration of the payments to be made by the Procuring Entity to the Contractor as specified in this Agreement, the Contractor hereby covenants with the Procuring Entity to execute the Works and to remedy defects there in inconformity in all respects with the provisions of the Contract.
4. The Procuring Entity hereby covenants to pay the Contractor in consideration of the execution and completion of the Works and the remedying of defects therein, the Contract Price or such other sum as may become payable under the provisions of the Contract at the times and in the manner prescribed by the Contract.

IN WITNESS whereof the parties hereto have caused this Agreement to be executed in accordance with the Laws of Kenya on the day, month and year specified above.

Signed and sealed by _____ *(for the Procuring Entity)*

Signed and sealed by _____ *(for the Contractor)*.

FORM NO. 5 - PERFORMANCE SECURITY
[Option 1 - Unconditional Demand Bank Guarantee]

[Guarantor letterhead]

Beneficiary: *[insert name and Address of Procuring Entity]* **Date:** _____ *[Insert date of issue]*

Guarantor: *[Insert name and address of place of issue, unless indicated in the letterhead]*

1. We have been informed that _____ (hereinafter called "the Contractor") has entered into Contract No. _____ dated _____ with (name of Procuring Entity) _____ (the Procuring Entity as the Beneficiary), for the execution of _____ (herein after called" the Contract").
2. Furthermore, we understand that, according to the conditions of the Contract, a performance guarantee is required.
3. At the request of the Contractor, we as Guarantor, hereby irrevocably undertake to pay the Beneficiary any sum or sums not exceeding in total an amount of _____ (in words),¹ such sum being payable in the types and proportions of currencies in which the Contract Price is payable, upon receipt by us of the Beneficiary's complying demand supported by the Beneficiary's statement, whether in the demand itself or in a separate signed document accompanying or identifying the demand, stating that the Applicant is in breach of its obligation(s) under the Contract, without the Beneficiary needing to prove or to show grounds for your demand or the sum specified there in.
4. This guarantee shall expire, no later than the..... Day of.....,2.....,2, and any demand for payment under it must be received by us at the office indicated above on or before that date.
5. The Guarantor agrees to a one-time extension of this guarantee for a period not to exceed *[six months]* *[one year]*, in response to the Beneficiary's written request for such extension, such request to be presented to the Guarantor before the expiry of the guarantee.”

[Name of Authorized Official, signature(s) and seals/stamps]

Note: All italicized text (including footnotes) is for use in preparing this form and shall be deleted from the final product.

1The Guarantor shall insert an amount representing the percentage of the Accepted Contract Amount specified in the Letter of Acceptance, less provisional sums, if any, and denominated either in the currency of the Contract or a freely convertible currency acceptable to the Beneficiary.

2Insert the date twenty-eight days after the expected completion date as described in GC Clause 11.9. The Procuring Entity should note that in the event of an extension of this date for completion of the Contract, the Procuring Entity would need to request an extension of this guarantee from the Guarantor. Such request must be in writing and must be made prior to the expiration date established in the guarantee.

FORM No. 6- PERFORMANCESECURITY [Option2-Performance Bond]

[Note: Procuring Entities are advised to use Performance Security- Unconditional Demand Bank Guarantee instead of Performance Bond due to difficulties involved in calling Bond holder to action]

[Guarantor letterhead or SWIFT identifier code]

Beneficiary: *[insert name and Address of Procuring Entity]*

Date: _____ *[Insert date of issue]*

PERFORMANCE BOND No.: _____

Guarantor: *[Insert name and address of place of issue, unless indicated in the letterhead]*

1. By this Bond _____ as Principal (hereinafter called “the Contractor”) and _____ as Surety (hereinafter called “the Surety”), are held and firmly bound unto _____ as Obligee (hereinafter called “the Procuring Entity”) in the amount of _____ for the payment of which sum well and truly to be made in the types and proportions of currencies in which the Contract Price is payable, the Contractor and the Surety bind themselves, their heirs, executors, administrators, successors and assigns, jointly and severally, firmly by these presents.
2. WHEREAS the Contractor has entered into a written Agreement with the Procuring Entity dated the day of , 20 ____, for _____ in accordance with the documents, plans, specifications, and amendments there to, which to the extent here in provided for, are by reference made part here of and are here in after referred to as the Contract.
3. NOW, THEREFORE, the Condition of this Obligation is such that, if the Contractor shall promptly and faithfully perform the said Contract (including any amendments thereto), then this obligation shall be null and void; otherwise, it shall remain in full force and effect. Whenever the Contractor shall be, and declared by the Procuring Entity to be, in default under the Contract, the Procuring Entity having performed the Procuring Entity's obligations there under, the Surety may promptly remedy the default, or shall promptly:
 - (1) Complete the Contract in accordance with its terms and conditions; or
 - (2) obtain a tender or tenders from qualified tenderers for submission to the Procuring Entity for completing the Contract in accordance with its terms and conditions, and upon determination by the Procuring Entity and the Surety of the lowest responsive Tenderers, arrange for a Contract between such Tenderer, and Procuring Entity and make available as work progresses (even though there should be a default or a succession of defaults under the Contract or Contracts of completion arranged under this paragraph) sufficient funds to pay the cost of completion less the Balance of the Contract Price; but not exceeding, including other costs and damages for which the Surety may be liable here under, the amount set for thin the first paragraph hereof. The term “Balance of the Contract Price,” as used in this paragraph, shall mean the total amount payable by Procuring Entity to Contractor under the Contract, less the amount properly paid by Procuring Entity to Contractor; or
 - (3) pay the Procuring Entity the amount required by Procuring Entity to complete the Contract in accordance with its terms and conditions up to a total not exceeding the amount of this Bond.
4. The Surety shall not be liable for a greater sum than the specified penalty of this Bond.
5. Any suit under this Bond must be instituted before the expiration of one year from the date of the issuing of the Taking-Over Certificate. No right of action shall accrue on this Bond to or for the use of any person or corporation other than the Procuring Entity named here in or the heirs, executors, administrators, successors, and assigns of the Procuring Entity.
6. In testimony whereof, the Contractor has hereunto set his hand and affixed his seal, and the Surety has caused these presents to be sealed with his corporate seal duly attested by the signature of his legal representative, this day _____ of _____ 20_____.

SIGNED ON _____ on behalf of

By _____ in the capacity of in the presence of

SIGNED ON _____ on behalf of

By _____ in the capacity of in the presence of

FORM NO. 7 - ADVANCE PAYMENT SECURITY [Demand Bank Guarantee]

[Guarantor letterhead]

Beneficiary: _____ *[Insert name and Address of Procuring Entity]*

Date: _____ *[Insert date of issue]* **ADVANCE PAYMENT**

GUARANTEE No.: *[Insert guarantee reference number]* **Guarantor:** *[Insert name*

and address of place of issue, unless indicated in the letterhead]

1. We have been informed that _____ (herein after called "the Contractor") has entered in to Contract No. _____ dated _____ with the Beneficiary, for the execution of _____ (herein after called "the Contract").
2. Furthermore, we understand that, according to the conditions of the Contract, an advance payment in the sum _____ (in words) is to be made against an advance payment guarantee.
3. At the request of the Contractor, we as Guarantor, hereby irrevocably undertake to pay the Beneficiary any sum or sums not exceeding in total an amount of _____ (in words _____), upon receipt by us of the Beneficiary's complying demand supported by the Beneficiary's statement, whether in the demand itself or in a separate signed document accompanying or identifying the demand, stating either that the Applicant:
 - a) Has used the advance payment for purposes other than the costs of mobilization in respect of the Works; or
 - b) has failed to repay the advance payment in accordance with the Contract conditions, specifying the amount which the Applicant has failed to repay.
4. A demand under this guarantee may be presented as from the presentation to the Guarantor of a certificate from the Beneficiary's bank stating that the advance payment referred to above has been credited to the Contractor on its account number _____ at _____.
5. The maximum amount of this guarantee shall be progressively reduced by the amount of the advance payment repaid by the Contractor as specified in copies of interim statements or payment certificates which shall be presented to us. This guarantee shall expire, at the latest, upon our receipt of a copy of the interim payment certificate indicating that ninety (90) percent of the Accepted Contract Amount, less provisional sums, has been certified for payment, or on the day of _____, 2 ,2 whichever is earlier. Consequently, any demand for payment under this guarantee must be received by us at this office on or before that date.
6. The Guarantor agrees to a one-time extension of this guarantee for a period not to exceed *[six months]* *[one year]*, in response to the Beneficiary's written request for such extension, such request to be presented to the Guarantor before the expiry of the guarantee.

Official, signature(s) and seals/stamps] *[Name of Authorized*

Note: All italicized text (including footnotes) is for use in preparing this form and shall be deleted from the final product.

The Guarantor shall insert an amount representing the amount of the advance payment and denominated either in the currency of the advance payment as specified in the Contract.

Insert the expected expiration date of the Time for Completion. The Procuring Entity should note that in the event of an extension of the time for completion of the Contract, the Procuring Entity would need to request an extension of this guarantee from the Guarantor. Such request must be in writing and must be made prior to the expiration date established in the guarantee.

FORM NO. 8 - RETENTION MONEY SECURITY [Demand Bank Guarantee]

[Guarantor letterhead]

Beneficiary: _____ *[Insert name and Address of Procuring Entity]*

Date: _____ *[Insert date of issue]*

Advance payment guarantee no. *[Insert guarantee reference number]*

Guarantor: *[Insert name and address of place of issue, unless indicated in the letterhead]*

1. We have been informed that _____ *[insert name of Contractor, which in the case of a joint venture shall be the name of the joint venture]* (herein after called "the Contractor") has entered in to Contract No. _____ *[insert reference number of the contract]* dated _____ with the Beneficiary, for the execution of _____ *[insert name of contract and brief description of Works]* (hereinafter called "the Contract").
2. Furthermore, we understand that, according to the conditions of the Contract, the Beneficiary retains moneys up to the limit set for thin the Contract ("the Retention Money"), and that when the Taking-Over Certificate has been issued under the Contract and the first half of the Retention Money has been certified for payment, and payment of *[insert the second half of the Retention Money]* is to be made against a Retention Money guarantee.
3. At the request of the Contractor, we, as Guarantor, hereby irrevocably under take to pay the Beneficiary any sum or sums not exceeding in total an amount of *[insert amount in figures]* _____ *[insert amount in words]* _____), upon receipt by us of the Beneficiary's complying demand supported by the Beneficiary's statement, whether in the demand itself or in a separate signed document accompanying or identifying the demand, stating that the Contractor is in breach of its obligation (s) under the Contract, without your needing to prove or show grounds for your demand or the sum specified there in.
4. A demand under this guarantee may be presented as from the presentation to the Guarantor of a certificate from the Beneficiary's bank stating that the second half of the Retention Money as referred to above has been credited to the Contractor on its account number _____ at _____ *[insert name and address of Applicant's bank]*.
5. This guarantee shall expire no later than the..... Day of.....,2...2, and any demand for payment under it must be received by us at the office indicated above on or before that date.
6. The Guarantor agrees to a one-time extension of this guarantee for a period not to exceed *[six months]* *[one year]*, in response to the Beneficiary's written request for such extension, such request to be presented to the Guarantor before the expiry of the guarantee.

[Name of Authorized Official, signature(s) and seals/stamps]

Note: All italicized text (including footnotes) is for use in preparing this form and shall be deleted from the final product.

¹The Guarantor shall insert an amount representing the amount of the second half of the Retention Money.

²Insert a date that is twenty-eight days after the expiry of retention period after the actual completion date of the contract. The Procuring Entity should note that in the event of an extension of this date for completion of the Contract, the Procuring Entity would need to request an extension of this guarantee from the Guarantor. Such request must be in writing and must be made prior to the expiration date established in the guarantee.

FORM NO. 9 BENEFICIAL OWNERSHIP DISCLOSURE FORM
(Amended and issued pursuant to PPRA CIRCULAR No. 02/2022)

INSTRUCTIONS TO TENDERERS: DELETE THIS BOX ONCE YOU HAVE COMPLETED THE FORM

This Beneficial Ownership Disclosure Form (“Form”) is to be completed by the successful tenderer pursuant to Regulation 13 (2A) and 13 (6) of the Companies (Beneficial Ownership Information) Regulations, 2020. In case of joint venture, the tenderer must submit a separate Form for each member. The beneficial ownership information to be submitted in this Form shall be current as of the date of its submission.

For the purposes of this Form, a Beneficial Owner of a Tenderer is any natural person who ultimately owns or controls the legal person (tenderer) or arrangements or a natural person on whose behalf a transaction is conducted, and includes those persons who exercise ultimate effective control over a legal person (Tenderer) or arrangement.

Tender Reference No.: _____ [insert identification no]

Name of the Tender Title/Description: _____ [insert name of the assignment] to:
 _____ [insert complete name of Procuring Entity]

In response to the requirement in your notification of award dated _____ [insert date of notification of award] to furnish additional information on beneficial ownership: _____ [select one option as applicable and delete the options that are not applicable]

I) We here by provide the following beneficial ownership information.

Details of beneficial ownership

	Details of all Beneficial Owners		% of shares a person holds in the company Directly or indirectly	% of voting rights a person holds in the company	Whether a person directly or indirectly holds a right to appoint or remove a member of the board of directors of the company or an equivalent governing body of the Tenderer (Yes / No)	Whether a person directly or indirectly exercises significant influence or control over the Company (tenderer) (Yes / No)
1.	Full Name		Directly----- ----- % of shares	Directly.....% of voting rights	1. Having the right to appoint a majority of the board of the directors or an equivalent governing body of the Tenderer: Yes -----No----- 2. Is this right held directly or indirectly?: Direct..... Indirect.....	1. Exercises significant influence or control over the Company body of the Company (tenderer) Yes -----No-- -- 2. Is this influence or control exercised directly or indirectly? Direct.....
	National identity card number or Passport number					
	Personal Identification Number (where applicable)		Indirectly---- ----- % of shares	Indirectly----- -% of voting rights		
	Nationality					
	Date of birth [dd/mm/yyyy]					
	Postal address					
	Residential address					
	Telephone number					
	Email address					

Details of all Beneficial Owners		% of shares a person holds in the company Directly or indirectly	% of voting rights a person holds in the company	Whether a person directly or indirectly holds a right to appoint or remove a member of the board of directors of the company or an equivalent governing body of the Tenderer (Yes / No)	Whether a person directly or indirectly exercises significant influence or control over the Company (tenderer) (Yes / No)
Occupation or profession					Indirect..... ...
2.	Full Name	Directly----- ----- % of shares	Directly.....% of voting rights	1. Having the right to appoint a majority of the board of the directors or an equivalent governing body of the Tenderer: Yes ----No---- 2. Is this right held directly or indirectly?: Direct..... Indirect.....	1. Exercises significant influence or control over the Company body of the Company (tenderer) Yes -----No-- -- 2. Is this influence or control exercised directly or indirectly? Direct..... Indirect.....
	National identity card number or Passport number				
	Personal Identification Number (where applicable)	Indirectly---- ----- % of shares	Indirectly----- -% of voting rights		
	Nationality(ies)				
	Date of birth [dd/mm/yyyy]				
	Postal address				
	Residential address				
	Telephone number				
	Email address				
	Occupation or profession				
3.					
e.t					
.c					

II) Am fully aware that beneficial ownership information above shall be reported to the Public Procurement Regulatory Authority together with other details in relation to contract awards and shall be maintained in the Government Portal, published and made publicly available pursuant to Regulation 13(5) of the Companies (Beneficial Ownership Information) Regulations, 2020.(Notwithstanding this paragraph Personally Identifiable Information in line with the Data Protection Act shall not be published or made public). *Note that Personally Identifiable Information (PII) is defined as any information that can be used to distinguish one person from another and can be used to deanonymize previously anonymous data. This information includes National identity card number or Passport number, Personal Identification Number, Date of birth, Residential address, email address and Telephone number.*

III) In determining who meets the threshold of who a beneficial owner is, the Tenderer must consider a natural person who in relation to the company:

- (a) holds at least ten percent of the issued shares in the company either directly or indirectly;
- (b) exercises at least ten percent of the voting rights in the company either directly or indirectly;
- (c) holds a right, directly or indirectly, to appoint or remove a director of the company; or
- (d) exercises significant influence or control, directly or indirectly, over the company.

IV) What is stated to herein above is true to the best of my knowledge, information and belief.

Name of the Tenderer:[insert complete name of the Tenderer]_____*

*Name of the person duly authorized to sign the Tender on behalf of the Tenderer: ** [insert complete name of person duly authorized to sign the Tender]*

Designation of the person signing the Tender: [insert complete title of the person signing the Tender]

Signature of the person named above: [insert signature of person whose name and capacity are shown above]

Date this [insert date of signing] day of..... [Insert month], [insert year]

Bidder Official Stamp



National Bank Building, 11th Floor, Harambee Avenue
KISM Towers , 6th Floor, Ngong Rd
Telephone: +254 020 3244000,

13106/7

Email: info@ppra.go.ke

Website:

www.ppra.go.ke

